

GROUP 35B

ANTI-LOCK BRAKING SYSTEM (ABS)

CONTENTS

GENERAL DESCRIPTION	35B-2	ON-VEHICLE SERVICE	35B-136
ABS DIAGNOSIS	35B-5	WHEEL SPEED SENSOR OUTPUT	
INTRODUCTION TO ABS DIAGNOSIS ...	35B-5	VOLTAGE MEASUREMENT.....	35B-136
ABS DIAGNOSTIC TROUBLESHOOTING		HYDRAULIC UNIT CHECK.....	35B-138
STRATEGY.....	35B-5	IN THE EVENT OF A DISCHARGED	
DIAGNOSTIC FUNCTION	35B-6	BATTERY	35B-140
DIAGNOSTIC TROUBLE CODE CHART ..	35B-10	HYDRAULIC UNIT	35B-141
DIAGNOSTIC TROUBLE CODE		REMOVAL AND INSTALLATION	35B-141
PROCEDURES.....	35B-11	WHEEL SPEED SENSOR	35B-145
SYMPTOM CHART.....	35B-116	REMOVAL AND INSTALLATION	35B-145
SYMPTOM PROCEDURES	35B-117	INSPECTION.....	35B-146
DATA LIST REFERENCE TABLE	35B-131	SPECIFICATIONS	35B-148
ACTUATOR TEST REFERENCE TABLE..	35B-131	FASTENER TIGHTENING	
CHECK AT ABS-ECU.....	35B-132	SPECIFICATION.....	35B-148
SPECIAL TOOLS	35B-134	GENERAL SPECIFICATIONS	35B-148
		SERVICE SPECIFICATION	35B-148

GENERAL DESCRIPTION

M1352000100744

FEATURES

The 4ABS ensures directional stability and control during hard braking.

This ABS uses a 4-sensor 4-channel system that controls all four wheels independently of each other.

- EBD (Electronic Brake-force Distribution system) control has been added to provide the ideal braking force for the rear wheels.

EBD CONTROL

In ABS, electronic control is used so the rear wheel brake hydraulic pressure during braking is regulated by rear wheel control solenoid valves in accordance with the vehicle rate of deceleration, and the front and rear wheel slippage which are calculated from the signals received from the various wheel sensors. EBD control is a control system which provides a high level of control for both vehicle braking force and vehicle stability. The system has the following features:

- To shorten the lines and enhance data transaxle reliability, communication with other ECU is performed over a CAN (Controller Area Network).
NOTE: For further details on CAN communication, refer to GROUP 54C, CAN P.54C-6.
- Fail-safe function which ensures that safety is maintained.
- Diagnostic function which provides improved serviceability.

- Because the system provides the optimum rear wheel braking force regardless of vehicle load and the condition of the road surface, the system reduces the required pedal depression force, particularly when the vehicle is heavily loaded.
- Because the duty placed on the front brakes is reduced, the increases in pad temperature can be controlled during front brake application to improve pad wear.
- Control valves such as the proportioning valve are not required.

CONSTRUCTION DIAGRAM

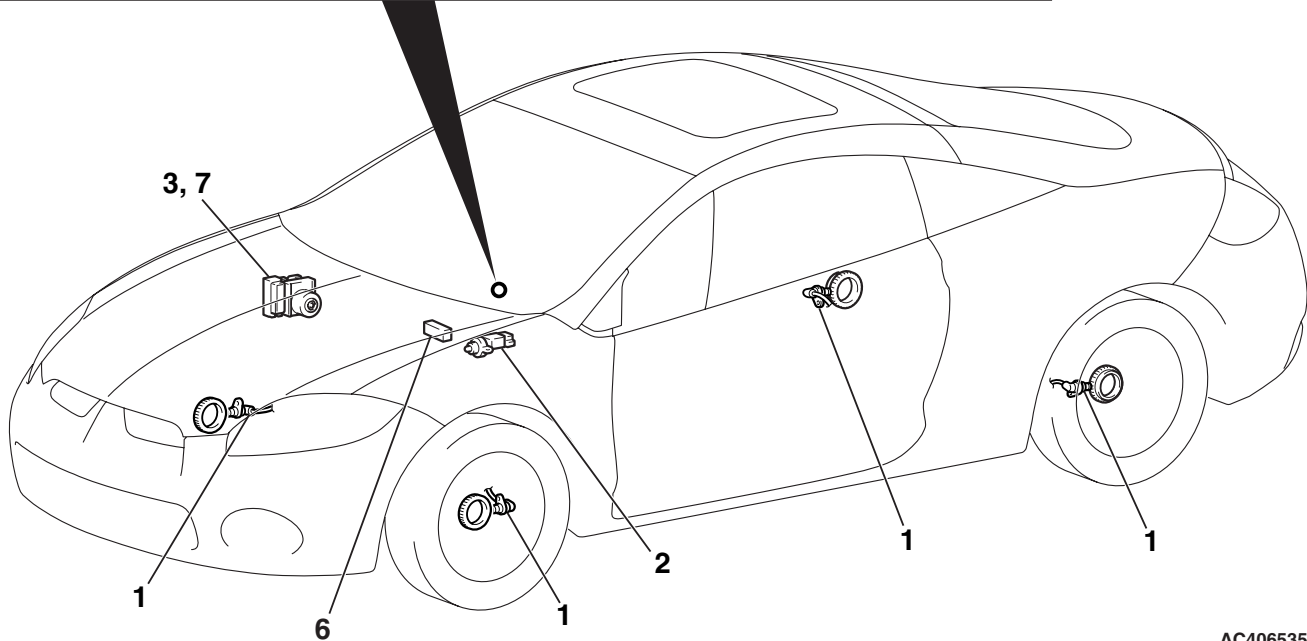
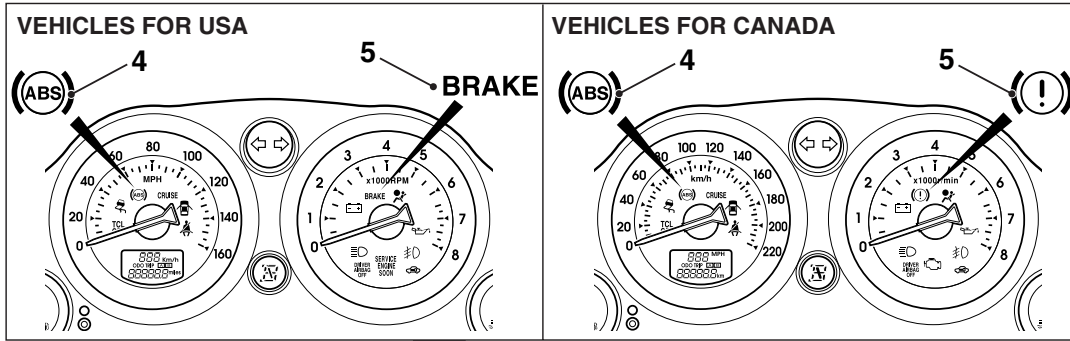

AC406535AB

NAME OF PART		NUMBER	OUTLINE OF FUNCTION
Sensor	Wheel speed sensor	1	Sends alternating current signals at frequencies which are proportional to the rotation speeds of each wheel to the ABS-ECU.
	Stoplight switch	2	Sends a signal to the ABS-ECU to indicate whether the brake pedal is depressed or not.
Actuator	Hydraulic unit	3	Drives the solenoid valves according to signals from the ABS-ECU in order to control the brake hydraulic pressure for each wheel.
	ABS warning light	4	Illuminates in response to signals from the ABS-ECU when a problem develops in the ABS system.
	Brake warning light	5	Illuminates in response to signals from the ABS-ECU when a problem develops in the EBD system.
Data link connector		6	Outputs the diagnostic trouble codes and allows communication with the scan tool.
ABS-ECU		7	Controls actuators (described above) based on the signals coming from each sensor.
			Controls the self-diagnosis and fail-safe functions.
			Controls the diagnostic function (scan tool compatible).

SYSTEM CHECK SOUND

When the vehicle speed reaches 10 km/h (6 mph) after ignition switch ON, a thudding sound can sometimes be heard coming from the engine compartment. This is a normal sound during the ABS self-check.

ABS OPERATION SOUNDS AND SENSATIONS

During normal operation, the ABS makes several sounds that may seem unusual at first:

- A whining sound is caused by the ABS hydraulic unit motor.
- When pressure is applied to the brake pedal, the pulsation of the pedal causes a scraping sound.

- When the brakes are applied firmly, the ABS operates, rapidly applying and releasing the brakes many times per second. This repeated application and release of braking forces can cause the suspension to make a thumping sound and the tires to squeak.

LONG STOPPING DISTANCES ON LOOSE ROAD SURFACES

When braking on loose surfaces like snow-covered or gravel roads, the stopping distance can be longer for an ABS-equipped vehicle than the stopping distance for a vehicle with a conventional brake system.

SHOCK AT STARTING CHECK

Shock may be felt when the brake pedal is lightly pressed while driving at a low speed. This is a normal characteristic because the ABS system operation check is carried out when vehicle speed is 8 km/h (5 mph) or less.

ABS DIAGNOSIS

INTRODUCTION TO ABS DIAGNOSIS

The ABS operates differently from conventional brake systems. These differences include sounds, sensations, and vehicle performance that owners and service technicians who are not familiar with ABS may not be used to.

Some operational characteristics may seem to be malfunctions, but they are simply signs of normal ABS operation. When diagnosing the ABS system, keep these operational characteristics in mind. Inform the owner of the kind of performance characteristics to expect from an ABS-equipped vehicle.

ABS DIAGNOSTIC TROUBLESHOOTING STRATEGY

Use these steps to plan your diagnostic strategy. If you follow them carefully, you will be sure that you have exhausted most of the possible ways to find an ABS fault.

1. Gather information about the problem from the customer.
2. Verify that the condition described by the customer exists.
3. Check the vehicle for any ABS DTC.
4. If you cannot verify the condition and there are no ABS DTCs, the malfunction is intermittent. Refer to GROUP 00, How to use Troubleshooting/Inspection Service Points –How to Cope with Intermittent Malfunctions [P.00-14](#).
5. If you can verify the condition but there are no ABS DTCs, or the system cannot communicate with the scan tool, check that the basic brake system is operating properly.

M1352012500493

ABS DIAGNOSTIC TROUBLE CODE DETECTION CONDITIONS

ABS diagnostic trouble codes (ABS DTCs) are set under different conditions, depending on the malfunction detected. Most ABS DTCs will only be set during vehicle operation. Some ABS DTCs will also be set during the ABS self-check immediately after the engine is started.

When you check if an ABS DTC will be displayed again after the DTC has been erased, you should duplicate the ABS DTC set conditions. Depending on the detection timing and set conditions for the specific ABS DTC, you must either drive the vehicle or turn the engine off and restart it. To set the proper conditions for that DTC again, refer to "ABS DTC SET CONDITIONS" for each ABS DTC that you are trying to reset.

M1352011100823

- If the basic brake system is not operating properly, refer to the GROUP 35A, Basic Brake System Diagnosis [P.35A-4](#).
 - If the basic brake system is operating properly, refer to [P.35B-116](#).
6. If there is an ABS DTC, record the number of the DTC, then erase the DTC from the memory using the scan tool.
NOTE: Any DTCs stored in the ABS-ECU cannot be erased if there is a malfunction.
 7. Duplicate the ABS DTC set conditions to see if the same ABS DTC will set again.
 - If the same ABS DTC sets again or the ABS DTC cannot be erased, perform the diagnostic procedures for the DTC. Refer to [P.35B-10](#).
 - If you cannot get the same ABS DTC to set again, the malfunction is intermittent. Refer to GROUP 00, How to use Troubleshooting/Inspection Service Points –How to Cope with Intermittent Malfunctions [P.00-14](#).

DIAGNOSTIC FUNCTION**ON-BOARD DIAGNOSTICS**

If the ABS-ECU detects any problem in the CAN communication line or the ECUs, which the ABS-ECU is communicating with, it stores a diagnostic trouble code. The DTCs have 26 items. The DTCs can be confirmed by connecting scan tool MB991958

(MUT-III sub assembly). The stored DTCs are not erased even after the ignition switch has been turned to the "LOCK" (OFF) position, or the battery has been disconnected. The DTCs can be erased by operating scan tool MB991958 (MUT-III sub assembly).

HOW TO CONNECT THE SCAN TOOL (MUT-III)**Required Special Tools:**

- MB991958: Scan Tool (MUT-III Sub Assembly)
 - MB991824: Vehicle Communication Interface (V.C.I.)
 - MB991827: MUT-III USB Cable
 - MB991910: MUT-III Main Harness A

⚠ CAUTION

To prevent damage to scan tool MB991958, always turn the ignition switch to the "LOCK" (OFF) position before connecting or disconnecting scan tool MB991958.

1. Ensure that the ignition switch is at the "LOCK" (OFF) position.
2. Start up the personal computer.
3. Connect special tool MB991827 to special tool MB991824 and the personal computer.
4. Connect special tool MB991910 to special tool MB991824.
5. Connect special tool MB991910 to the data link connector.
6. Turn the power switch of special tool MB991824 to the "ON" position.

NOTE: When special tool MB991824 is energized, special tool MB991824 indicator light will be illuminated in a green color.

7. Start the MUT-III system on the personal computer.

NOTE: Disconnecting scan tool MB991958 is the reverse of the connecting sequence, making sure that the ignition switch is at the "LOCK" (OFF) position.

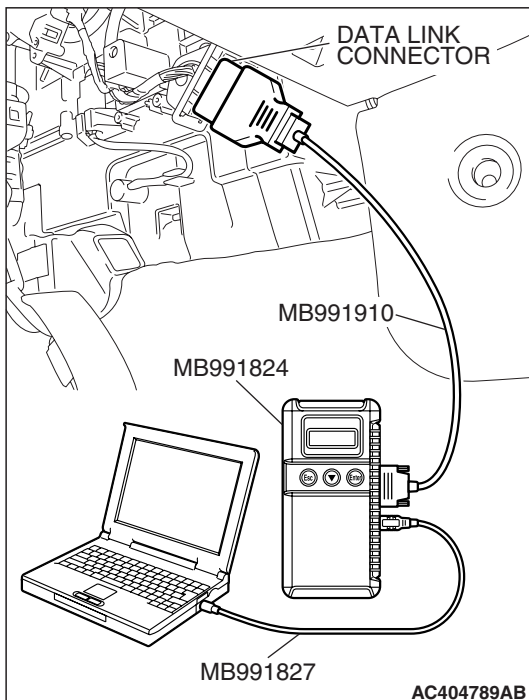
**HOW TO READ AND ERASE DIAGNOSTIC TROUBLE CODES****Required Special Tools:**

- MB991958: Scan Tool (MUT-III Sub Assembly)
 - MB991824: V.C.I.
 - MB991827: MUT-III USB Cable
 - MB991910: MUT-III Main Harness A

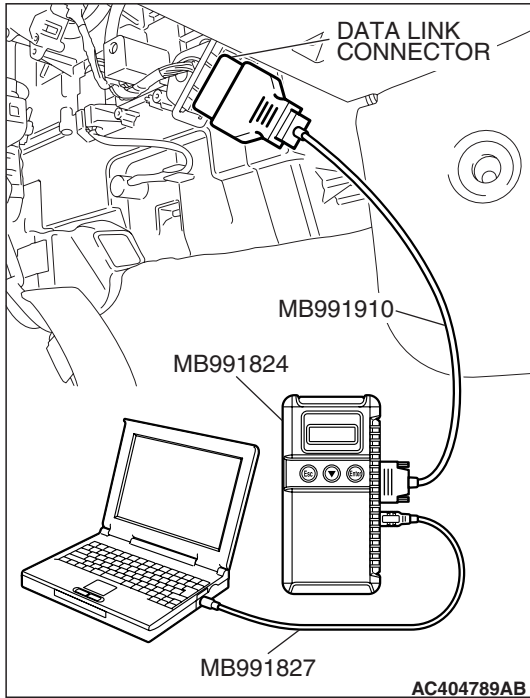

CAUTION

To prevent damage to scan tool MB991958, always turn the ignition switch to the "LOCK" (OFF) position before connecting or disconnecting scan tool MB991958.

NOTE: If the battery voltage is low, diagnostic trouble codes will not be set. Check the battery if scan tool MB991958 does not display.

1. Connect scan tool MB991958 to the data link connector.
2. Turn the ignition switch to the "ON" position.
3. Select "Interactive Diagnosis" from the start-up screen.
4. Select "System select."
5. Choose "ABS" from the "CHASSIS" tab.
6. Select "Diagnostic Trouble Code."
7. If a DTC is set, it is shown.
8. Choose "Erase DTCs" to erase the DTC.

HOW TO READ DATA LIST

Required Special Tools:

- MB991958: Scan Tool (MUT-III Sub Assembly)
 - MB991824: V.C.I.
 - MB991827: MUT-III USB Cable
 - MB991910: MUT-III Main Harness A

CAUTION

To prevent damage to scan tool MB991958, always turn the ignition switch to the "LOCK" (OFF) position before connecting or disconnecting scan tool MB991958.

1. Connect scan tool MB991958 to the data link connector.
2. Turn the ignition switch to the "ON" position.
3. Select "Interactive Diagnosis" from the start-up screen.
4. Select "System Select."
5. Choose "ABS" from the "CHASSIS" tab.
6. Select "MITSUBISHI."
7. Select "Data List."
8. Choose an appropriate item and select the "OK" button.

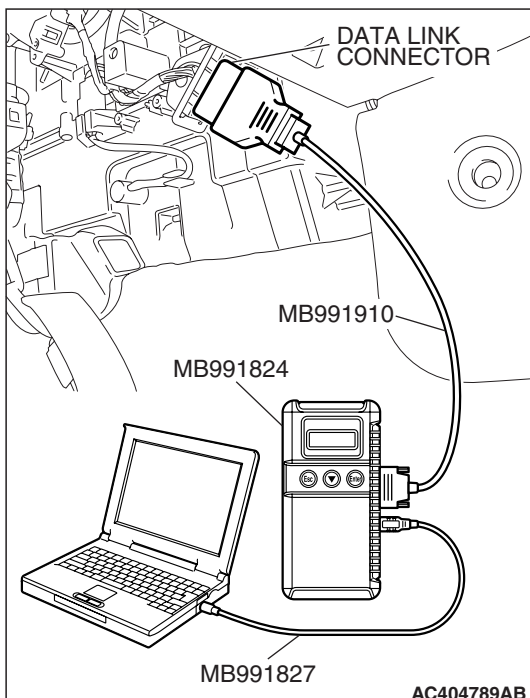

HOW TO PERFORM ACTUATOR TEST**Required Special Tools:**

- MB991958: Scan Tool (MUT-III Sub Assembly)
 - MB991824: V.C.I.
 - MB991827: MUT-III USB Cable
 - MB991910: MUT-III Main Harness A

⚠ CAUTION

To prevent damage to scan tool MB991958, always turn the ignition switch to the "LOCK" (OFF) position before connecting or disconnecting scan tool MB991958.

1. Connect scan tool MB991958 to the data link connector.
2. Turn the ignition switch to the "ON" position.
3. Select "Interactive Diagnosis" from the start-up screen.
4. Select "System Select."
5. Choose "ABS" from the "CHASSIS" tab.
6. Choose "Actuator Test" from "ABS" screen.
7. Choose an appropriate item and select the "OK" button.

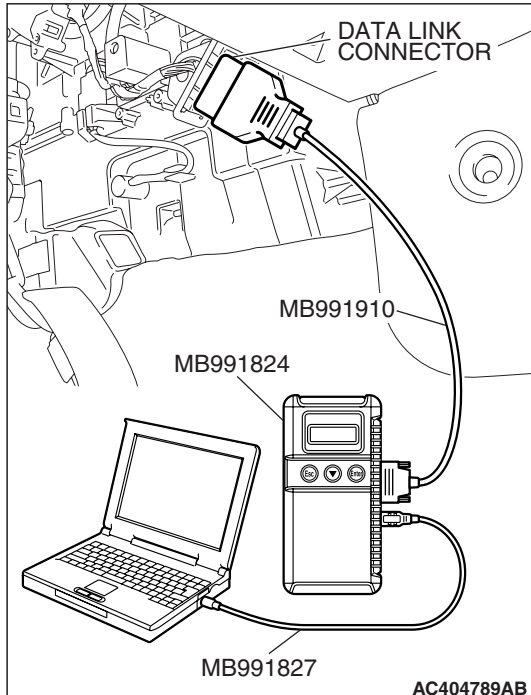
**HOW TO DIAGNOSE THE CAN BUS LINES****Required Special Tools:**

- MB991958: Scan Tool (MUT-III Sub Assembly)
 - MB991824: V.C.I.
 - MB991827: MUT-III USB Cable
 - MB991910: MUT-III Main Harness A

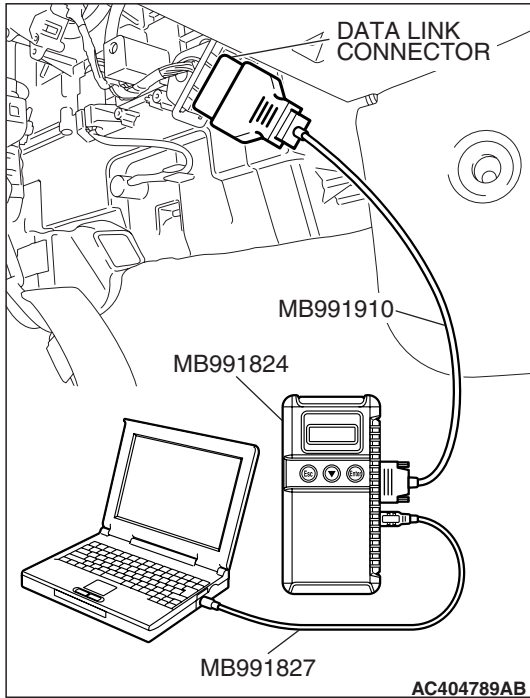

⚠ CAUTION

To prevent damage to scan tool MB991958, always turn the ignition switch to the "LOCK" (OFF) position before connecting or disconnecting scan tool MB991958.

1. Connect scan tool MB991958 to the data link connector.
2. Turn the ignition switch to the "ON" position.
3. Select "CAN bus diagnosis" from the start-up screen.
4. When the vehicle information is displayed, confirm that it matches the vehicle being diagnosed.
 - If they match, go to step 8.
 - If not, go to step 5.
5. Select the "view vehicle information" button.
6. Enter the vehicle information and select the "OK" button.
7. When the vehicle information is displayed, confirm again that it matches the vehicle being diagnosed.
 - If they match, go to step 8.
 - If not, go to step 5.
8. Select the "OK" button.
9. When the optional equipment screen is displayed, choose the one which the vehicle is fitted with, and then select the "OK" button.

DIAGNOSTIC TROUBLE CODE CHART

⚠ CAUTION

During diagnosis, a DTC code associated with another system may be set when the ignition switch is turned on with connector(s) disconnected. On completion, confirm all systems for DTCs. If DTC code(s) are set, erase them all.

Follow the inspection chart that is appropriate for the diagnostic trouble code.

DTC	INSPECTION ITEM	DIAGNOSTIC CONTENT	REFERENCE PAGE
C1200	Front right wheel speed sensor	Open circuit or short circuit	P.35B-11
C1201	Front right wheel speed sensor	Abnormal output signal	P.35B-20
C1205	Front left wheel speed sensor	Open circuit or short circuit	P.35B-29
C1206	Front left wheel speed sensor	Abnormal output signal	P.35B-38
C1210	Rear right wheel speed sensor	Open circuit or short circuit	P.35B-47
C1211	Rear right wheel speed sensor	Abnormal output signal	P.35B-57
C1215	Rear left wheel speed sensor	Open circuit or short circuit	P.35B-67
C1216	Rear left wheel speed sensor	Abnormal output signal	P.35B-77
C1226	ABS front right solenoid valve (pressure holding system)		P.35B-87
C1231	ABS front right solenoid valve (depressurizing system)		P.35B-87
C1236	ABS front left solenoid valve (pressure holding system)		P.35B-87
C1241	ABS front left solenoid valve (depressurizing system)		P.35B-87
C1246	ABS rear right solenoid valve (pressure holding system)		P.35B-87
C1251	ABS rear right solenoid valve (depressurizing system)		P.35B-87
C1256	ABS rear left solenoid valve (pressure holding system)		P.35B-87
C1261	ABS rear left solenoid valve (depressurizing system)		P.35B-87
C1271	Motor circuit failure		P.35B-95
C1276	Power supply circuit failure of valves		P.35B-103
C1607	ECU failure	Valve relay cannot activate	P.35B-105
		Valve relay can activate	
C1860	Power supply high voltage		P.35B-107
C1861	Power supply low voltage		P.35B-107
U1073	Bus off		P.35B-114

*NOTE: Since the ABS system is controlled with the same ABS/TCL-ECU used to control the TCL system, the codes (with a *) used only for the ABS system also appear.*

*Inspection procedures for the codes (with a *) used only for the TCL system are not described in this section.*

DIAGNOSTIC TROUBLE CODE PROCEDURES

DTC C1200: Front right Wheel Speed Sensor (Open Circuit or Short Circuit)

Wheel Speed Sensor Circuit

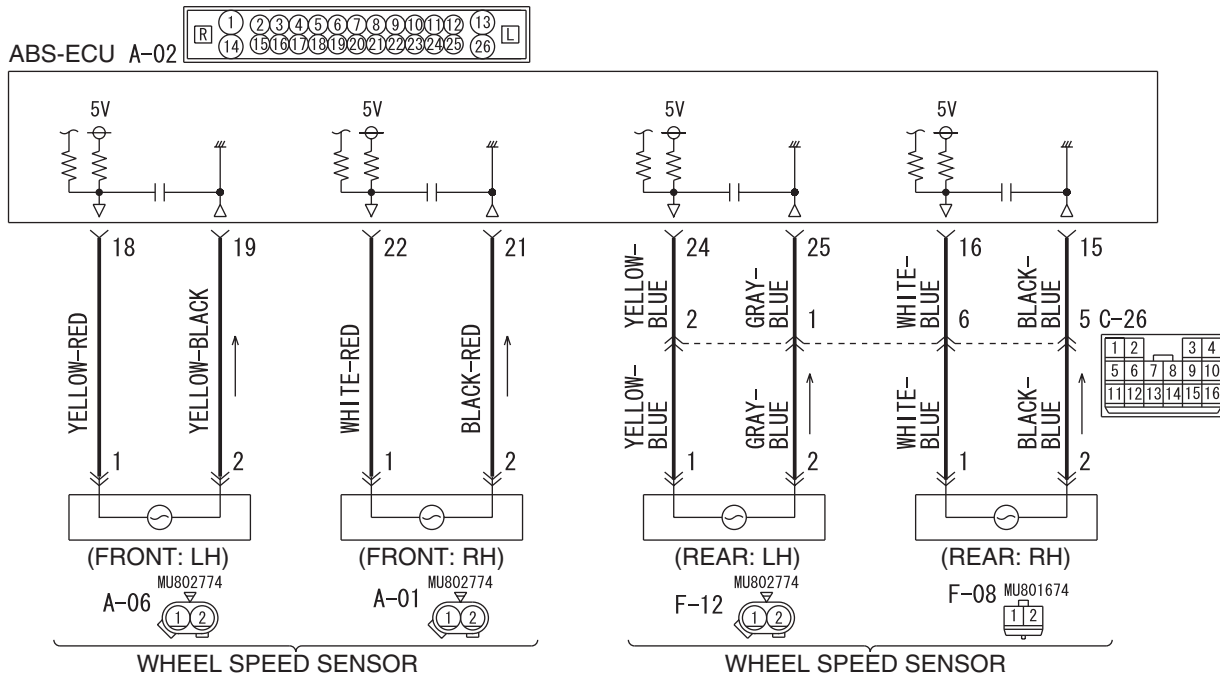

W6P35M000A

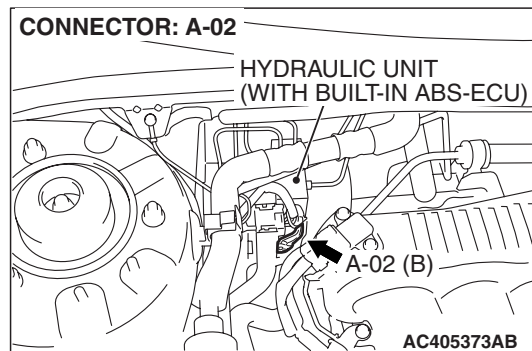
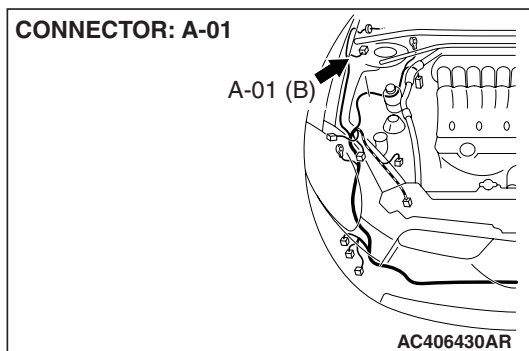

CAUTION

If there is any problem in the CAN bus lines, an incorrect diagnostic trouble code may be set. Prior to this diagnosis, diagnose the CAN bus lines. (Refer to GROUP 54C, Trouble code diagnosis P.54C-12).

CIRCUIT OPERATION

- A toothed wheel speed rotor generates a voltage pulse as it moves across the pickup field of each wheel speed sensor.

- The amount of voltage generated at each wheel is determined by the clearance between the wheel speed rotor teeth and the wheel speed sensor, and by the speed of rotation.
- Sends alternating current signals at frequencies which are proportional to the rotation speeds of each wheel to the ABS electronic control unit (ABS-ECU).
- The ABS hydraulic unit modulates the amount of braking force individually applied to each wheel cylinder.

ABS DTC SET CONDITIONS

The ABS-ECU monitors voltage fluctuation in each wheel speed sensor circuit. If the ECU detects a short or open circuit in the circuit, it will set a diagnostic trouble code.

TROUBLESHOOTING HINTS (THE MOST LIKELY CAUSES FOR THESE DTCS ARE TO SET ARE:)**Current trouble**

- Malfunction of the wheel speed sensor

- Damaged wiring harness or connector
- Malfunction of the hydraulic unit (integrated with ABS-ECU)

Past trouble

- Carry out diagnosis with particular emphasis on connector(s) or wiring harness in wheel speed sensor circuit. For diagnosis procedures, refer to "How to treat past trouble" (Refer to GROUP 00, How to treat past trouble [P.00-16](#)).

DIAGNOSIS**Required Special Tools:**

- MB991958: Scan Tool (MUT-III Sub Assembly)
 - MB991824: V.C.I.
 - MB991827: MUT-III USB Cable
 - MB991910: MUT-III Main Harness A
- MB991974: ABS Check Harness

STEP 1. Using scan tool MB991958, diagnose the CAN bus line.**⚠ CAUTION**

To prevent damage to scan tool MB991958, always turn the ignition switch to the "LOCK" (OFF) position before connecting or disconnecting scan tool MB991958.

- (1) Connect scan tool MB991958 to the data link connector.
- (2) Turn the ignition switch to the "ON" position.
- (3) Diagnose the CAN bus line.
- (4) Turn the ignition switch to the "LOCK" (OFF) position.

Q: Is the CAN bus line found to be normal?

YES : Go to Step 3

NO : Repair the CAN bus line (Refer to GROUP 54C, Diagnosis [P.54C-14](#)). Then go to Step 2.

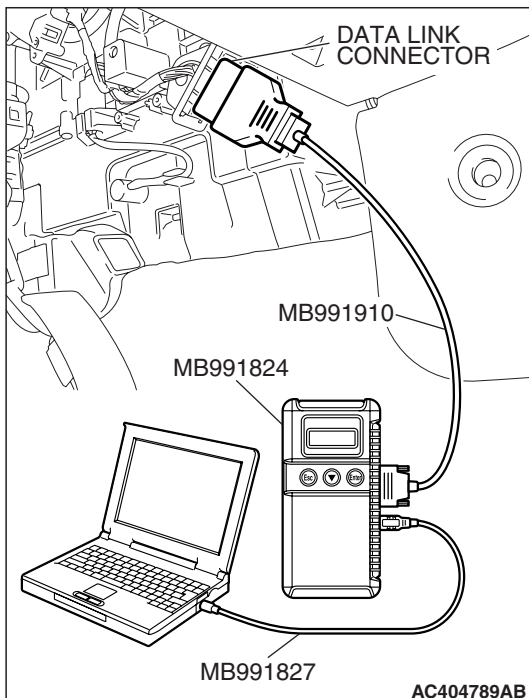

STEP 2. Recheck for diagnostic trouble code.

⚠ CAUTION

To prevent damage to scan tool MB991958, always turn the ignition switch to the "LOCK" (OFF) position before connecting or disconnecting scan tool MB991958.

- (1) Turn the ignition switch to the "ON" position.
- (2) Erase the DTC.
- (3) Turn the ignition switch to the "LOCK" (OFF) position.
- (4) Turn the ignition switch to the "ON" position.
- (5) Check if the DTC is set.
- (6) Turn the ignition switch to the "LOCK" (OFF) position.

Q: Is DTC C1200 set?

YES : Go to Step 3

NO : The procedure is complete.

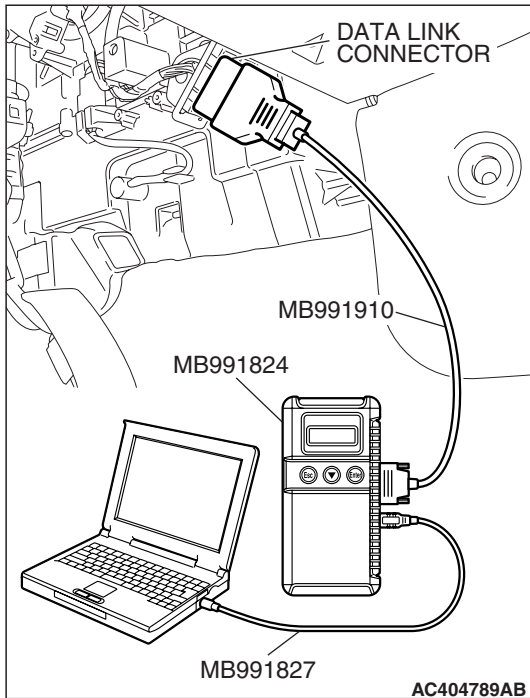

STEP 3. Using scan tool MB991958, check data list.

⚠ CAUTION

To prevent damage to scan tool MB991958, always turn the ignition switch to the "LOCK" (OFF) position before connecting or disconnecting scan tool MB991958.

- (1) Connect scan tool MB991958 to the data link connector.
- (2) Start the engine.
- (3) Set scan tool MB991958 to the data reading mode, and check the data list items by driving the vehicle (Refer to P.35B-131).

- Item 01: Front right wheel speed sensor

- (4) Turn the ignition switch to the "LOCK" (OFF) position.

Q: Does the speedometer indication match the scan tool indication?

YES : It can be assumed that this malfunction is intermittent.

Refer to GROUP 00, How to Use

Troubleshooting/Inspection Service Points –How to Cope with Intermittent Malfunction P.00-14.

NO : Go to Step 4.

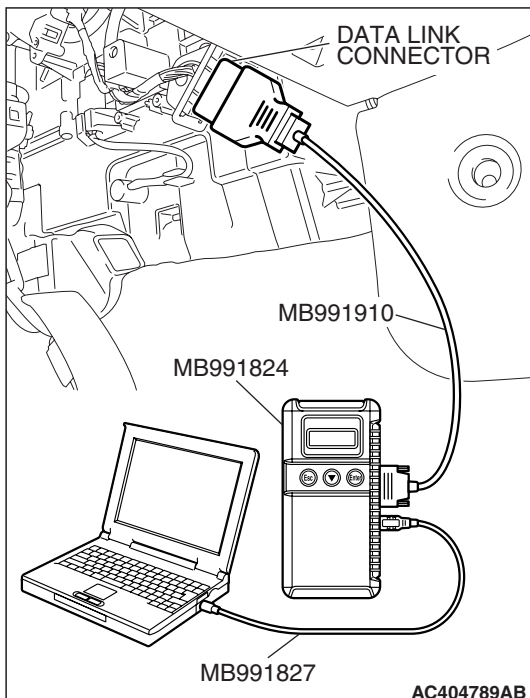

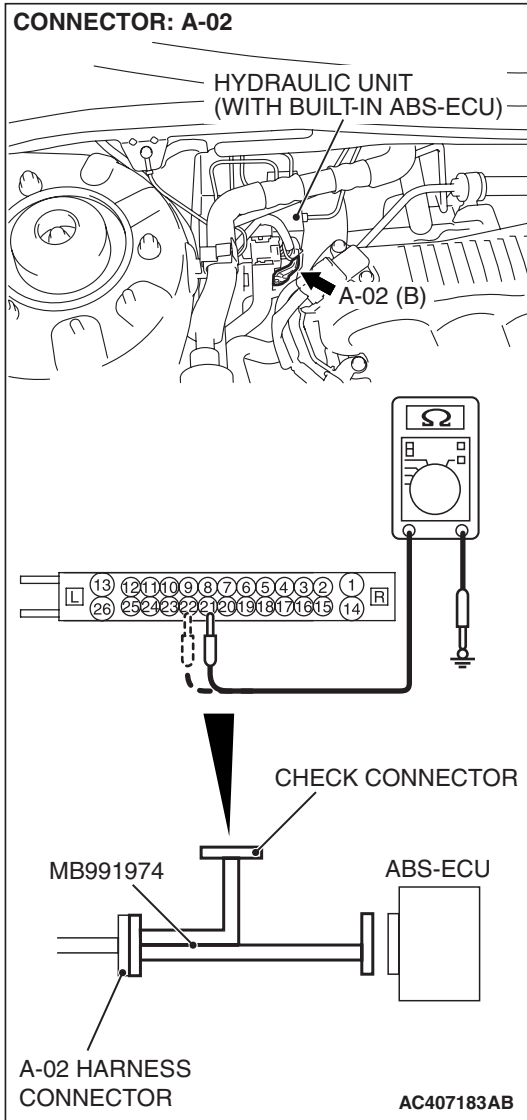

STEP 4. Measure the voltage at ABS-ECU connector A-02.

- (1) Disconnect the connector A-02, and connect special tool MB991974 to the wiring harness-side connector.

NOTE: Do not connect special tool MB991974 to the ABS-ECU.

- (2) Turn the ignition switch to the "ON" position.
- (3) Measure the voltage between terminal 21 and body ground, and between terminal 22 and body ground. It should be 1V or less.

Q: Does the voltage measure 1 V or less?

YES : Go to Step 5.

NO : Go to Step 7.

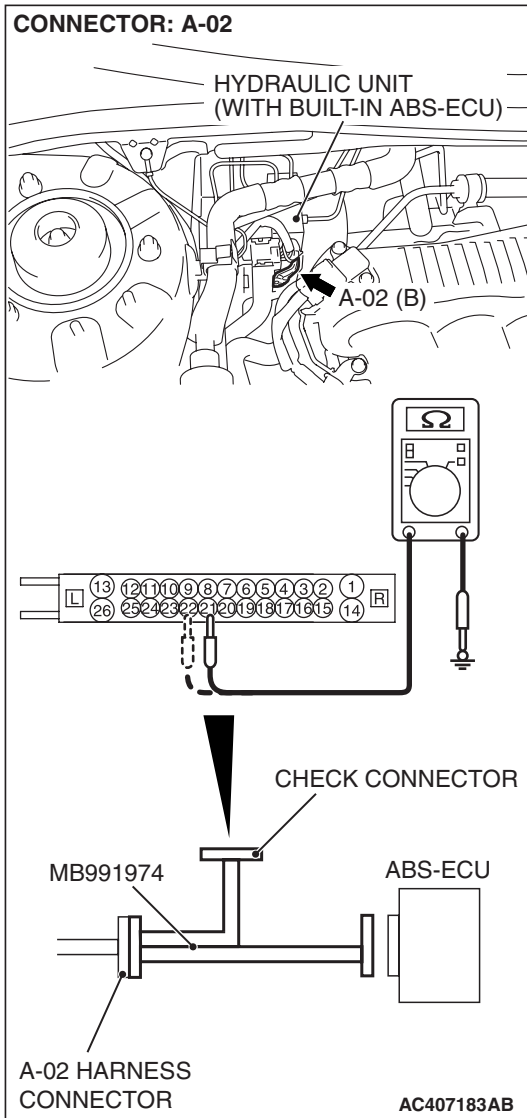

STEP 5. Measure the resistance at ABS-ECU connector A-02.

- (1) Disconnect the connector A-02, and connect special tool MB991974 to the wiring harness-side connector.

NOTE: Do not connect special tool MB991974 to the ABS-ECU.

- (2) Measure the resistance between terminal 21 and body ground, and between terminal 22 and body ground. There should be no continuity.

Q: Does continuity exist?

YES : Go to Step 7.

NO : Go to Step 6.

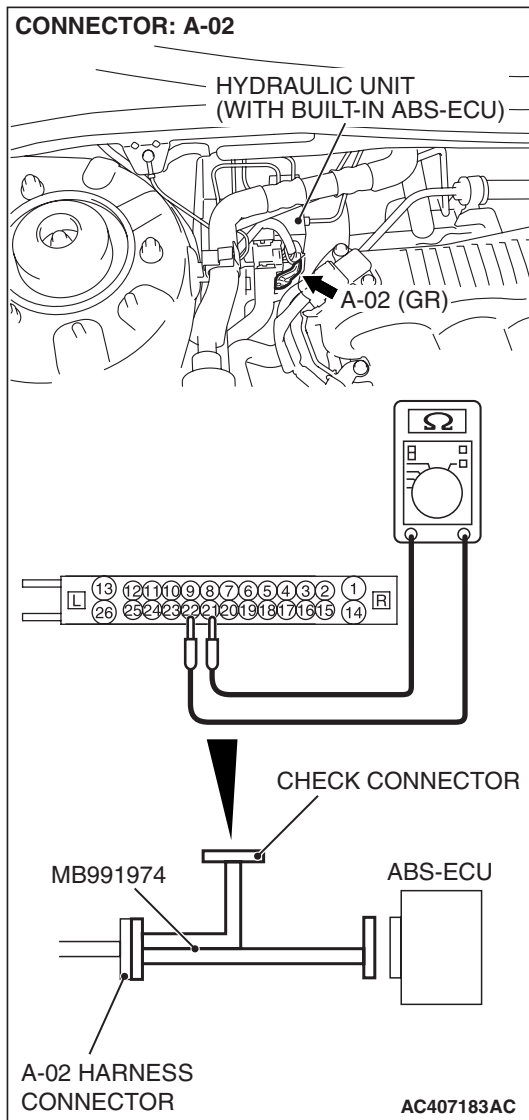

STEP 6. Measure the resistance at the ABS-ECU connector A-02.

- (1) Disconnect the connector A-02, and connect special tool MB991974 to the wiring harness-side connector.

NOTE: Do not connect special tool MB991974 to the ABS-ECU.

- (2) Measure the resistance between the ABS-ECU connector terminals 21 and 22.

Standard Value: 1.24 – 1.64 k Ω

Q: Is the resistance between terminals 21 and 22 within the standard value?

YES : Go to Step 10.

NO : Go to Step 7.

STEP 7. Check ABS-ECU connector A-02 and wheel speed sensor <front: RH> connector A-01 for loose, corroded or damaged terminals, or terminals pushed back in the connector.

Q: Are ABS-ECU connector A-02 and wheel speed sensor <front: RH> connector A-01 damaged?

YES : Repair or replace the damaged component(s). Refer to GROUP 00E, Harness Connector Inspection

[P.00E-2](#). Then go to Step 11.

NO : Go to Step 8.

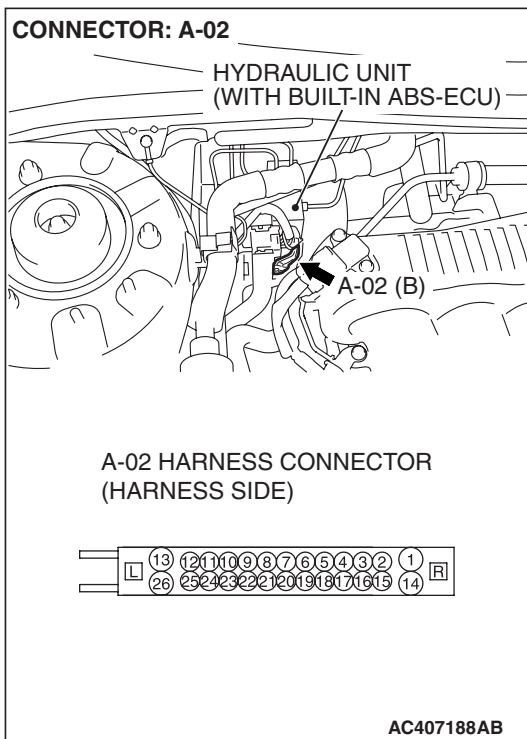
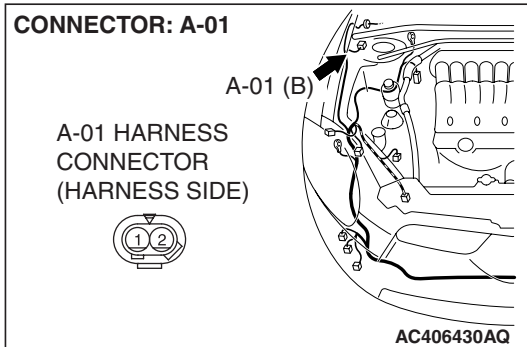

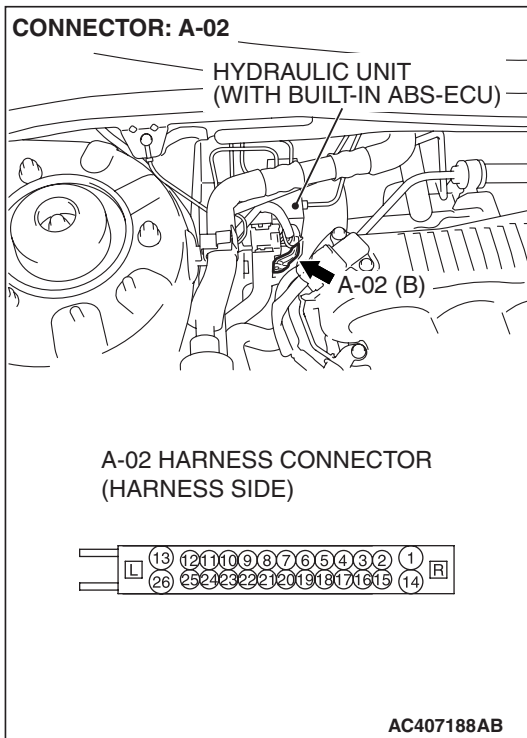
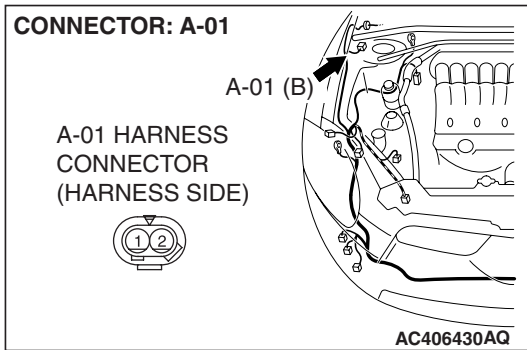

STEP 8. Check the harness wires between ABS-ECU connector A-02 (terminal 21, 22) and wheel speed sensor connector A-01 (terminal 2, 1).

Q: Is the harness wire between ABS-ECU connector A-02 (terminal 21, 22) and wheel speed sensor connector A-01 (terminal 2, 1) damaged?

YES : Repair the wiring harness. Then go to Step 11.
NO : Go to Step 9.

STEP 9. Inspect the wheel speed sensor.

Check the front right wheel speed sensor relevant to the DTC code. For the applicable inspection procedure, refer to [P.35B-146](#).

Q: Is the wheel speed sensor damaged?

YES : Replace the wheel speed sensor. Then go to Step 11.
NO : It can be assumed that this malfunction is intermittent. Refer to GROUP 00, How to Use Troubleshooting/Inspection Service Points –How to Cope with Intermittent Malfunction [P.00-14](#).

STEP 10. Recheck for diagnostic trouble code.

⚠ CAUTION

To prevent damage to scan tool MB991958, always turn the ignition switch to the "LOCK" (OFF) position before connecting or disconnecting scan tool MB991958.

Check again if the DTC is set.

- (1) Turn the ignition switch to the "ON" position.
- (2) Erase the DTC.
- (3) Turn the ignition switch to the "LOCK" (OFF) position.
- (4) Turn the ignition switch to the "ON" position.
- (5) Check if the DTC is reset.
- (6) Turn the ignition switch to the "LOCK" (OFF) position.

Q: Is DTC C1200 set?

YES : Replace the hydraulic unit (integrated with ABS-ECU). Then go to Step 11.

NO : It can be assumed that this malfunction is intermittent. Refer to GROUP 00, How to Use Troubleshooting/Inspection Service Points –How to Cope with Intermittent Malfunction [P.00-14](#).

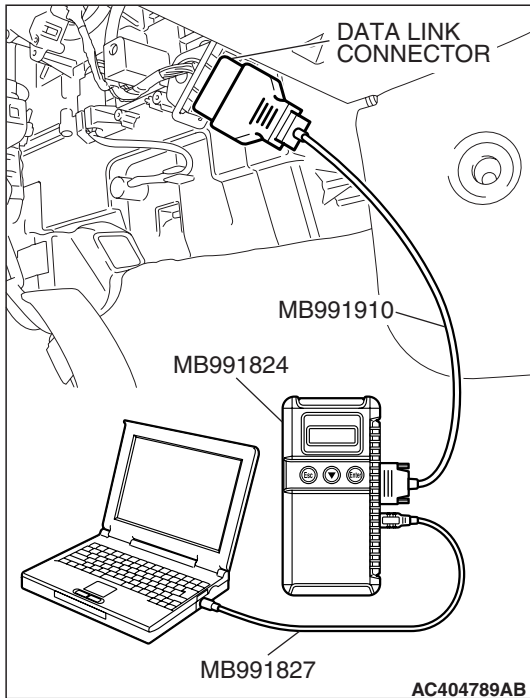

STEP 11. Recheck for diagnostic trouble code.

⚠ CAUTION

To prevent damage to scan tool MB991958, always turn the ignition switch to the "LOCK" (OFF) position before connecting or disconnecting scan tool MB991958.

- (1) Turn the ignition switch to the "ON" position.
- (2) Erase the DTC.
- (3) Turn the ignition switch to the "LOCK" (OFF) position.
- (4) Turn the ignition switch to the "ON" position.
- (5) Check if the DTC is set.
- (6) Turn the ignition switch to the "LOCK" (OFF) position.

Q: Is DTC C1200 set?

YES : Repeat the troubleshooting from Step 1.

NO : The procedure is complete.

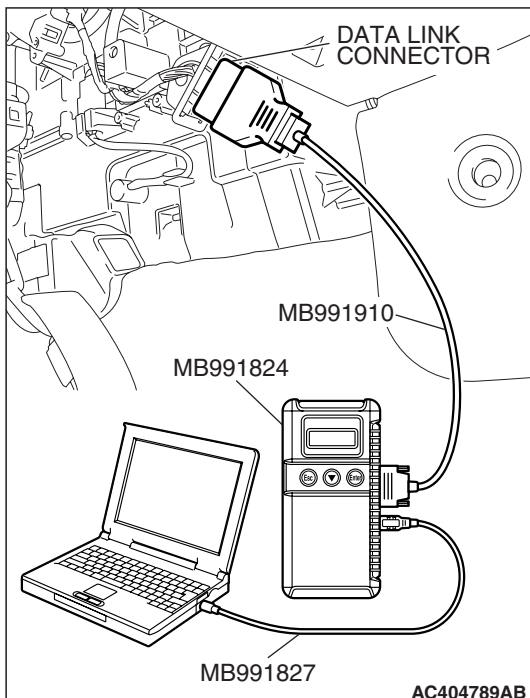

DTC C1201: Front Right Wheel Speed Sensor (Abnormal Output Signal)

Wheel Speed Sensor Circuit

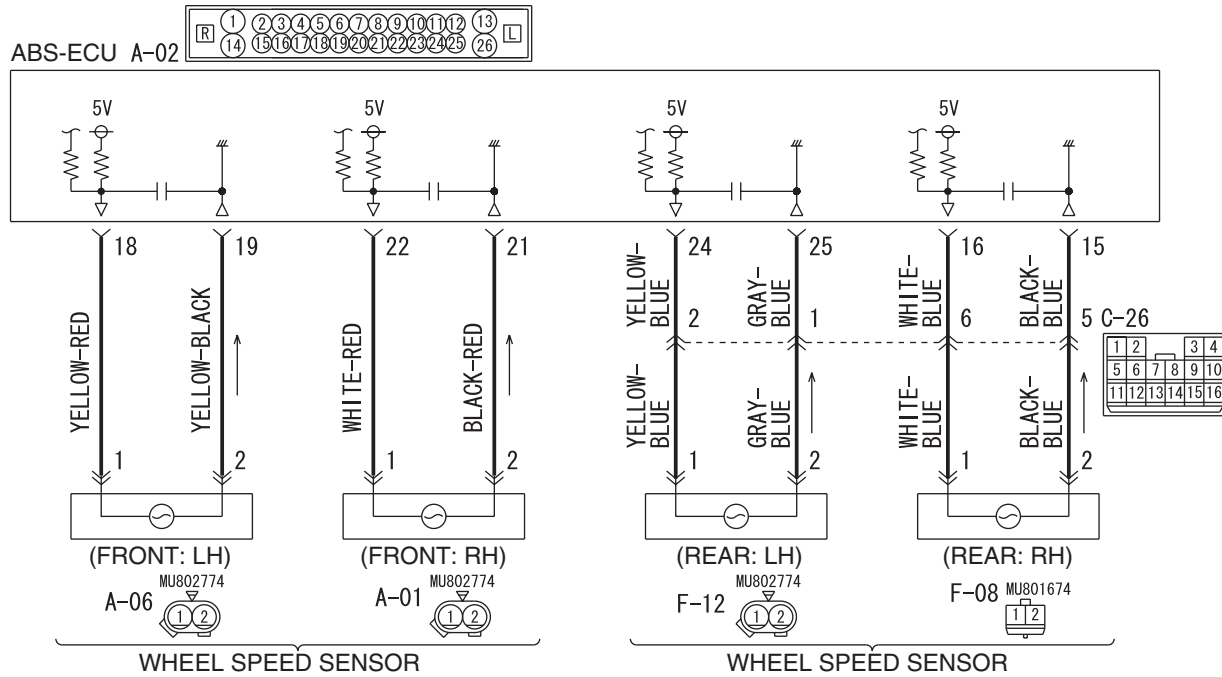

W6P35M000A

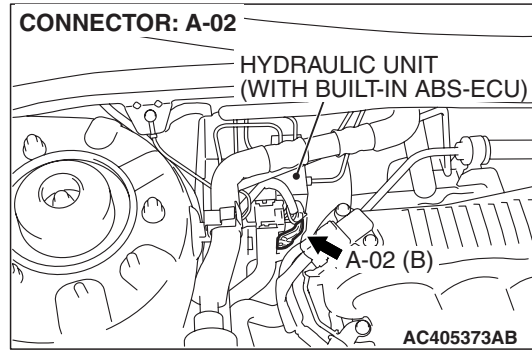
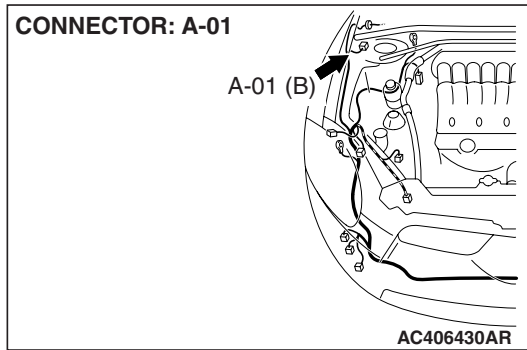

CAUTION

If there is any problem in the CAN bus lines, an incorrect diagnostic trouble code may be set. Prior to this diagnosis, diagnose the CAN bus lines. (Refer to GROUP 54C, Trouble code diagnosis P.54C-12).

CIRCUIT OPERATION

- A toothed wheel speed rotor generates a voltage pulse as it moves across the pickup field of each wheel speed sensor.

- The amount of voltage generated at each wheel is determined by the clearance between the wheel speed rotor teeth and the wheel speed sensor, and by the speed of rotation.
- Sends alternating current signals at frequencies which are proportional to the rotation speeds of each wheel to the ABS electronic control unit (ABS-ECU).
- The ABS hydraulic unit modulates the amount of braking force individually applied to each wheel cylinder.

ABS DTC SET CONDITIONS

The ABS-ECU monitors the signals from each wheel speed sensor while the vehicle is being driven. If any fault below is found in these sensor signals, the ECU will set the relevant diagnostic trouble code.

- Missing sensor signal
- Sensor signal, which will not be created under normal operation
- Significant difference among the wheel speed sensor signals

TROUBLESHOOTING HINTS (THE MOST LIKELY CAUSES FOR THESE DTCS ARE TO SET ARE:)

Current trouble

- Malfunction of the wheel speed sensor or wheel speed rotor
- Damaged wiring harness or connector
- Malfunction of the hydraulic unit (integrated with ABS-ECU)

Past trouble

- Carry out diagnosis with particular emphasis on connector(s) or wiring harness in wheel speed sensor circuit. For diagnosis procedures, refer to "How to treat past trouble" (Refer to GROUP 00, How to treat past trouble [P.00-16](#)).

DIAGNOSIS

Required Special Tools:

- MB991958: Scan Tool (MUT-III Sub Assembly)
 - MB991824: V.C.I.
 - MB991827: MUT-III USB Cable
 - MB991910: MUT-III Main Harness A
- MB991974: ABS Check Harness

STEP 1. Using scan tool MB991958, diagnose the CAN bus line.

CAUTION

To prevent damage to scan tool MB991958, always turn the ignition switch to the "LOCK" (OFF) position before connecting or disconnecting scan tool MB991958.

- (1) Connect scan tool MB991958 to the data link connector.
- (2) Turn the ignition switch to the "ON" position.
- (3) Diagnose the CAN bus line.
- (4) Turn the ignition switch to the "LOCK" (OFF) position.

Q: Is the CAN bus line found to be normal?

YES : Go to Step 3

NO : Repair the CAN bus line (Refer to GROUP 54C, Diagnosis [P.54C-14](#)). Then go to Step 2.

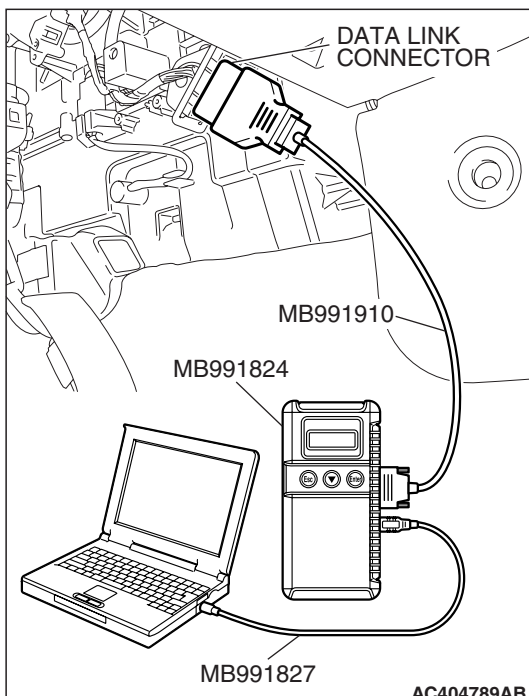

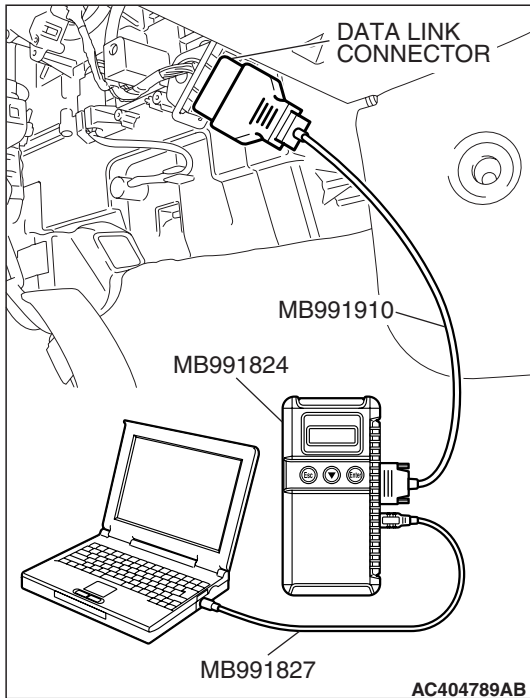
**STEP 2. Recheck for diagnostic trouble code.****⚠ CAUTION**

To prevent damage to scan tool MB991958, always turn the ignition switch to the "LOCK" (OFF) position before connecting or disconnecting scan tool MB991958.

- (1) Turn the ignition switch to the "ON" position.
- (2) Erase the DTC.
- (3) Turn the ignition switch to the "LOCK" (OFF) position.
- (4) Turn the ignition switch to the "ON" position.
- (5) Check if the DTC is set.
- (6) Turn the ignition switch to the "LOCK" (OFF) position.

Q: Is DTC C1201 set?

YES : Go to Step 3

NO : The procedure is complete.

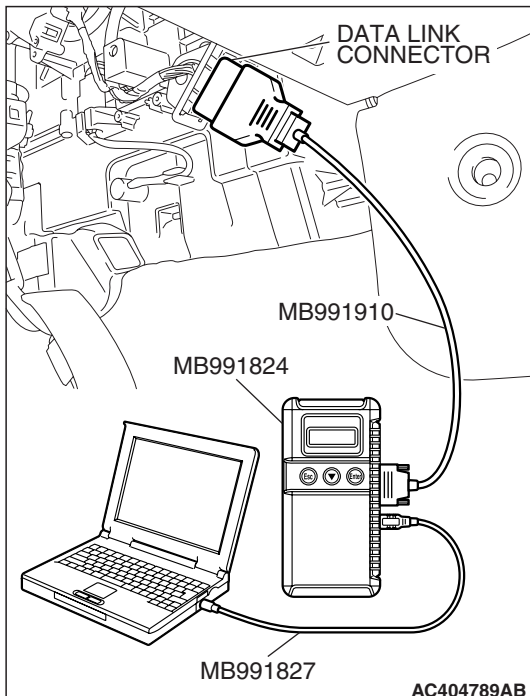
**STEP 3. Using scan tool MB991958, read the diagnostic trouble code.****⚠ CAUTION**

To prevent damage to scan tool MB991958, always turn the ignition switch to the "LOCK" (OFF) position before connecting or disconnecting scan tool MB991958.

Use scan tool MB991958 to check whether DTC code C1200 have been set simultaneously.

- (1) Connect scan tool MB991958 to the data link connector.
- (2) Turn the ignition switch to the "ON" position.
- (3) Check whether DTC C1200 have been set.
- (4) Turn the ignition switch to the "LOCK" (OFF) position.

Q: Is DTC C1200 set?

YES : Carry out diagnosis relevant to DTC C1200 (Refer to P.35B-11).

NO : Go to Step 4.

STEP 4. Check the installation condition of the wheel speed sensors.

For the wheel speed sensor, which the DTC code indicates, check whether the sensor or its mounting bolts are loosened.

- DTC C1201 is set: Front right wheel speed sensor

Q: Is the wheel speed sensor installed correctly?

YES : Go to Step 5.

NO : Reinstall the wheel speed sensor correctly. Then go to Step 13.

STEP 5. Check the wheel speed sensor after it is removed from the vehicle.

Check the wheel speed sensor which the DTC code indicates (Refer to [P.35B-146](#)).

- DTC C1201 is set: Front right wheel speed sensor

Q: Is the wheel speed sensor in good condition?

YES : Go to Step 6.

NO : Replace the wheel speed sensor (Refer to [P.35C-164](#)). Then go to Step 13.

STEP 6. Check the wheel bearing for looseness.

NOTE: If the wheel bearing is loose, the gap between the wheel speed sensor and rotor may become excessive. Check the wheel bearing, which DTC code indicates, for looseness.

- DTC C1201 is set: Check the front right wheel bearing (Refer to GROUP 26, On-vehicle service –Wheel bearing end play check [P.26-8](#)).

Q: Is the wheel bearing end play within the standard value?

YES : Go to Step 7.

NO : Replace the front hub assembly (Refer to GROUP 26, Front axle hub assembly [P.26-9](#)).

STEP 7. Check the wheel speed rotor.

Check the wheel speed rotor, which DTC code indicates, for foreign material or deformation.

- DTC C1201 is set: Front right wheel speed sensor

Q: Is the wheel speed rotor in good condition?

YES : Go to Step 8.

NO : If the wheel speed rotor is contaminated with foreign material, clean it. If the driveshaft is deformed, replace it (Refer to GROUP 26, Drive shaft assembly [P.26-14](#)).

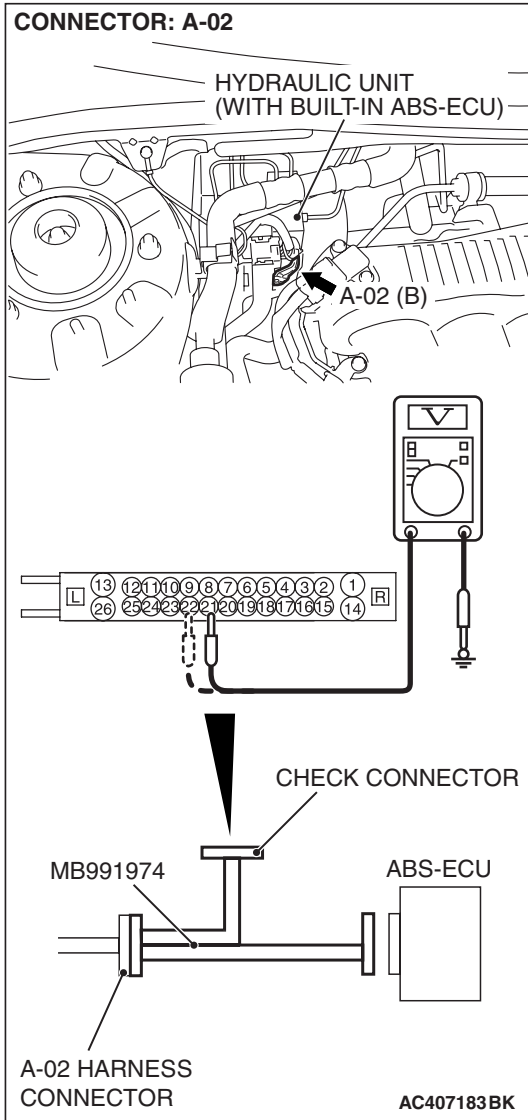

STEP 8. Measure the voltage at ABS-ECU connector A-02.

- (1) Disconnect the connector A-02, and connect special tool MB991974 to the wiring harness-side connector.

NOTE: Do not connect special tool MB991974 to the ABS-ECU.

- (2) Turn the ignition switch to the "ON" position.
- (3) Measure the voltage between terminal 21 and body ground, and between terminal 22 and body ground. It should be 1V or less.

Q: Does the voltage measure 1 V or less?

YES : Go to Step 9.

NO : Go to Step 11.

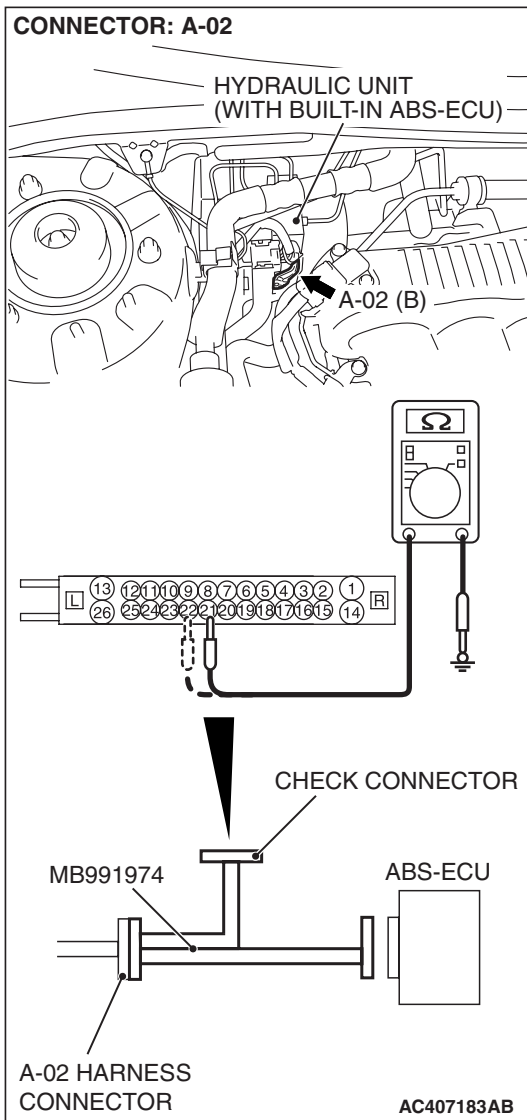

STEP 9. Measure the resistance at ABS-ECU connector A-02.

(1) Disconnect the connector A-02, and connect special tool MB991974 to the wiring harness-side connector.

NOTE: Do not connect special tool MB991974 to the ABS-ECU.

(2) Measure the resistance between terminal 21 and body ground, and between terminal 22 and body ground. There should be no continuity.

Q: Does continuity exist?

YES : Go to Step 11.

NO : Go to Step 10.

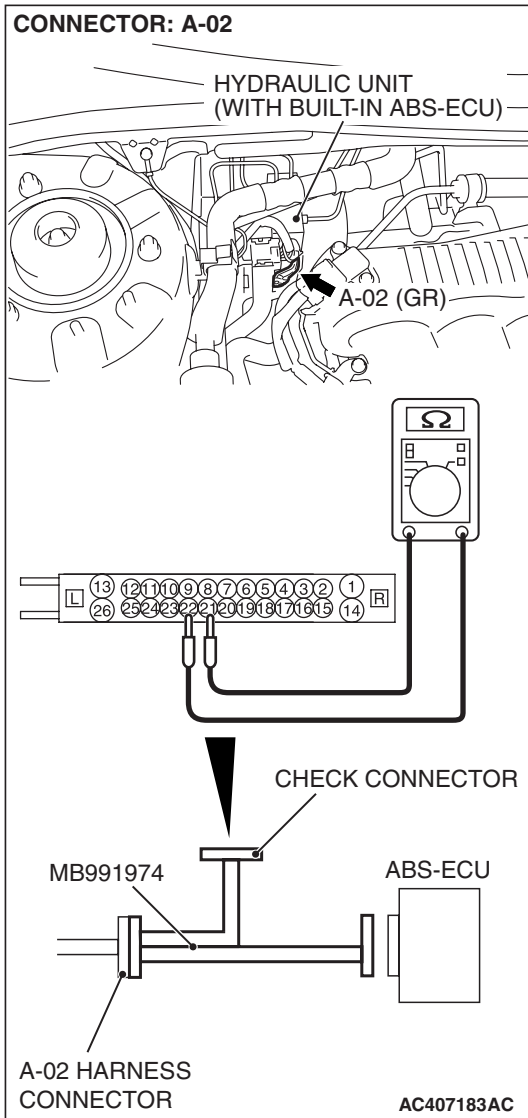

STEP 10. Measure the resistance at ABS-ECU connector A-02.

(1) Disconnect the connector A-02, and connect special tool MB991974 to the wiring harness-side connector.

NOTE: Do not connect special tool MB991974 to the ABS-ECU.

(2) Measure the resistance between terminals 21 and 22.

Standard Value: 1.24 – 1.64 kΩ

Q: Is the resistance between terminals 21 and 22 within the standard value?

YES : Go to Step 12.

NO : Go to Step 11.

STEP 11. Check ABS-ECU connector A-02 and wheel speed sensor <front: RH> connector A-01 for loose, corroded or damaged terminals, or terminals pushed back in the connector.

Q: Are ABS-ECU connector A-02 and wheel speed sensor <front: RH> connector A-01 damaged?

YES : Repair or replace the damaged component(s). Refer to GROUP 00E, Harness Connector Inspection

[P.00E-2](#). Then go to Step 13.

NO : Open or short circuit may be present in the front right wheel speed sensor circuit. Repair the wiring harness between ABS-ECU connector A-02 (terminals 21 and 22) and front right wheel speed sensor A-01 (terminals 2 and 1). Then go to Step 13.

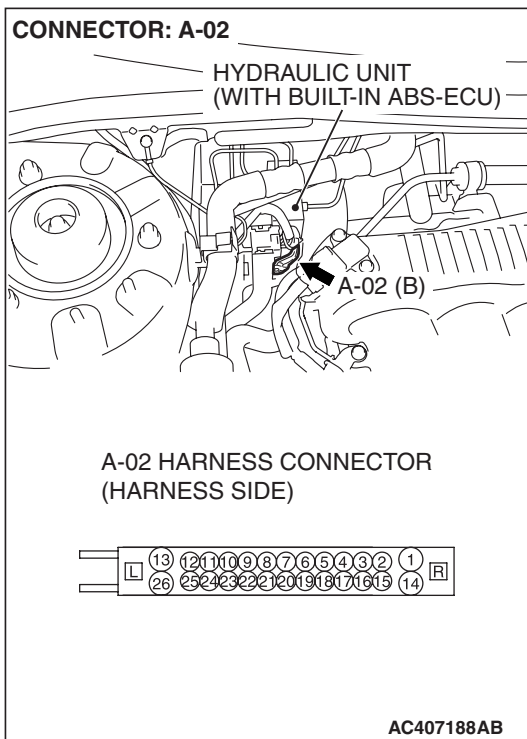
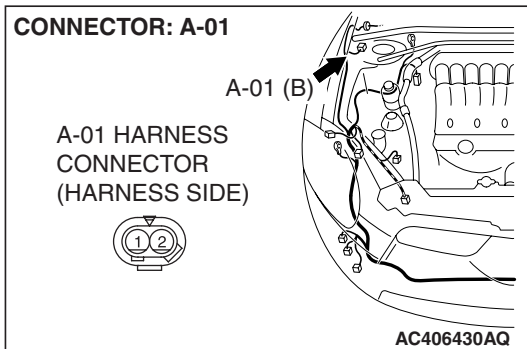

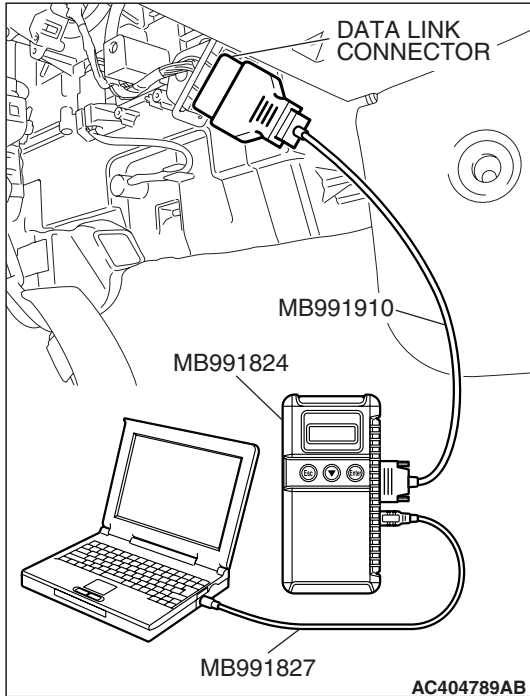
**STEP 12. Recheck for diagnostic trouble code.****⚠ CAUTION**

To prevent damage to scan tool MB991958, always turn the ignition switch to the "LOCK" (OFF) position before connecting or disconnecting scan tool MB991958.

Check again if the DTC is set.

- (1) Turn the ignition switch to the "ON" position.
- (2) Erase the DTC.
- (3) Turn the ignition switch to the "LOCK" (OFF) position.
- (4) Turn the ignition switch to the "ON" position.
- (5) Check if the DTC is set.
- (6) Turn the ignition switch to the "LOCK" (OFF) position.

Q: Is DTC C1201 set?

YES : Replace the hydraulic unit (integrated with ABS-ECU). Then go to Step 13.

NO : It can be assumed that this malfunction is intermittent. Refer to GROUP 00, How to Use Troubleshooting/Inspection Service Points –How to Cope with Intermittent Malfunction [P.00-14](#).

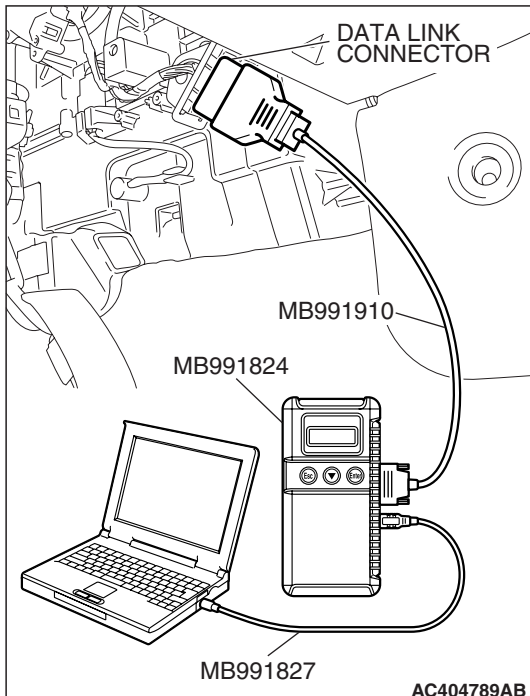
**STEP 13. Recheck for diagnostic trouble code.****⚠ CAUTION**

To prevent damage to scan tool MB991958, always turn the ignition switch to the "LOCK" (OFF) position before connecting or disconnecting scan tool MB991958.

Check again if the DTC is set.

- (1) Turn the ignition switch to the "ON" position.
- (2) Erase the DTC.
- (3) Turn the ignition switch to the "LOCK" (OFF) position.
- (4) Turn the ignition switch to the "ON" position.
- (5) Check if the DTC is set.
- (6) Turn the ignition switch to the "LOCK" (OFF) position.

Q: Is DTC C1201 set?

YES : Go to Step 1.

NO : The procedure is complete.

DTC C1205: Front Left Wheel Speed Sensor (Open Circuit or Short Circuit)

Wheel Speed Sensor Circuit

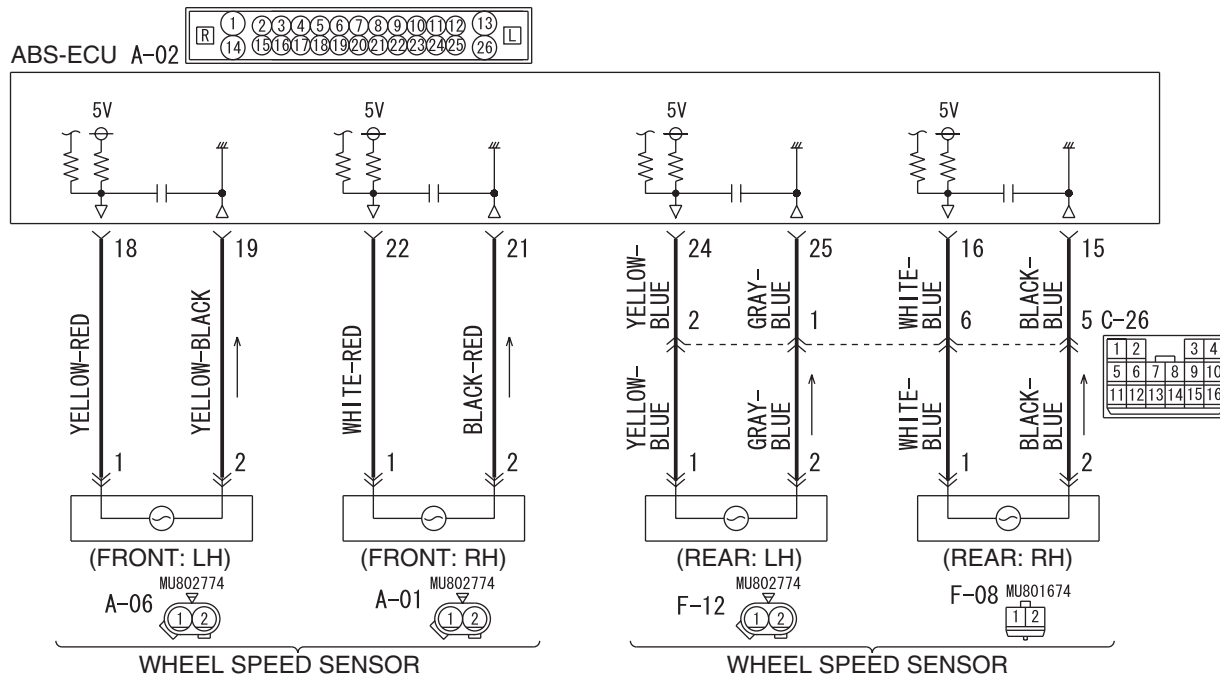

W6P35M000A

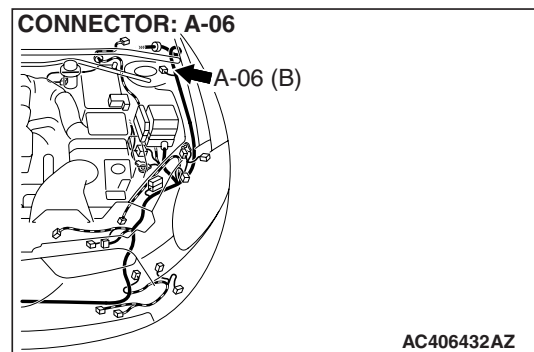
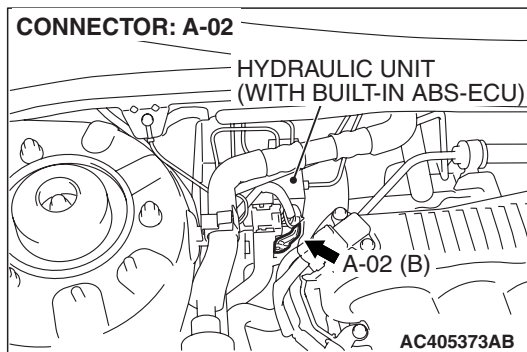

CAUTION

If there is any problem in the CAN bus lines, an incorrect diagnostic trouble code may be set. Prior to this diagnosis, diagnose the CAN bus lines. (Refer to GROUP 54C, Trouble code diagnosis P.54C-12).

CIRCUIT OPERATION

- A toothed wheel speed rotor generates a voltage pulse as it moves across the pickup field of each wheel speed sensor.
- The amount of voltage generated at each wheel is determined by the clearance between the wheel speed rotor teeth and the wheel speed sensor, and by the speed of rotation.

- Sends alternating current signals at frequencies which are proportional to the rotation speeds of each wheel to the ABS electronic control unit (ABS-ECU).
- The ABS hydraulic unit modulates the amount of braking force individually applied to each wheel cylinder.

ABS DTC SET CONDITIONS

The ABS-ECU monitors voltage fluctuation in each wheel speed sensor circuit. If the ECU detects a short or open circuit in the circuit, it will set a diagnostic trouble code.

TROUBLESHOOTING HINTS (THE MOST LIKELY CAUSES FOR THESE DTCS ARE TO SET ARE:)**Current trouble**

- Malfunction of the wheel speed sensor
- Damaged wiring harness or connector

- Malfunction of the hydraulic unit (integrated with ABS-ECU)

Past trouble

- Carry out diagnosis with particular emphasis on connector(s) or wiring harness in wheel speed sensor circuit. For diagnosis procedures, refer to "How to treat past trouble" (Refer to GROUP 00, How to treat past trouble P.00-16).

DIAGNOSIS**Required Special Tools:**

- MB991958: Scan Tool (MUT-III Sub Assembly)
 - MB991824: V.C.I.
 - MB991827: MUT-III USB Cable
 - MB991910: MUT-III Main Harness A
- MB991974: ABS Check Harness

STEP 1. Using scan tool MB991958, diagnose the CAN bus line.**⚠ CAUTION**

To prevent damage to scan tool MB991958, always turn the ignition switch to the "LOCK" (OFF) position before connecting or disconnecting scan tool MB991958.

- (1) Connect scan tool MB991958 to the data link connector.
- (2) Turn the ignition switch to the "ON" position.
- (3) Diagnose the CAN bus line.
- (4) Turn the ignition switch to the "LOCK" (OFF) position.

Q: Is the CAN bus line found to be normal?

YES : Go to Step 3

NO : Repair the CAN bus line (Refer to GROUP 54C, Diagnosis P.54C-14). Then go to Step 2.

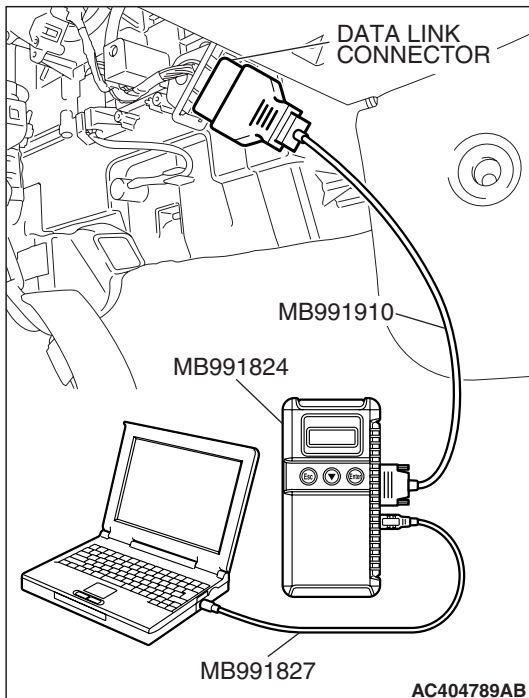

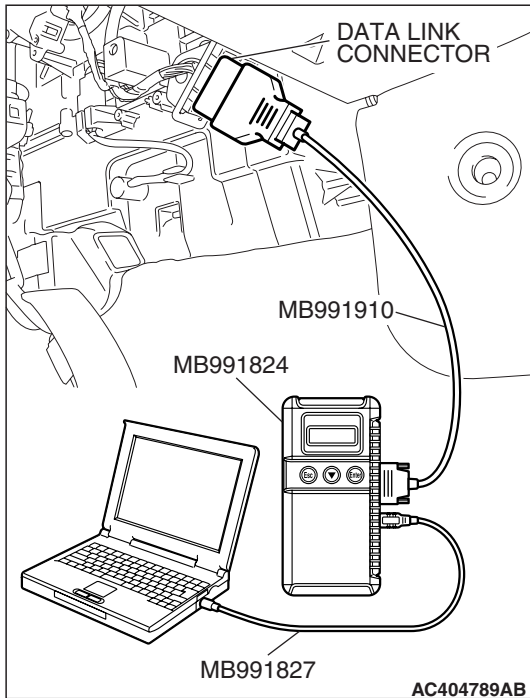

STEP 2. Recheck for diagnostic trouble code.

⚠ CAUTION

To prevent damage to scan tool MB991958, always turn the ignition switch to the "LOCK" (OFF) position before connecting or disconnecting scan tool MB991958.

- (1) Turn the ignition switch to the "ON" position.
- (2) Erase the DTC.
- (3) Turn the ignition switch to the "LOCK" (OFF) position.
- (4) Turn the ignition switch to the "ON" position.
- (5) Check if the DTC is set.
- (6) Turn the ignition switch to the "LOCK" (OFF) position.

Q: Is DTC C1205 set?

YES : Go to Step 3

NO : The procedure is complete.

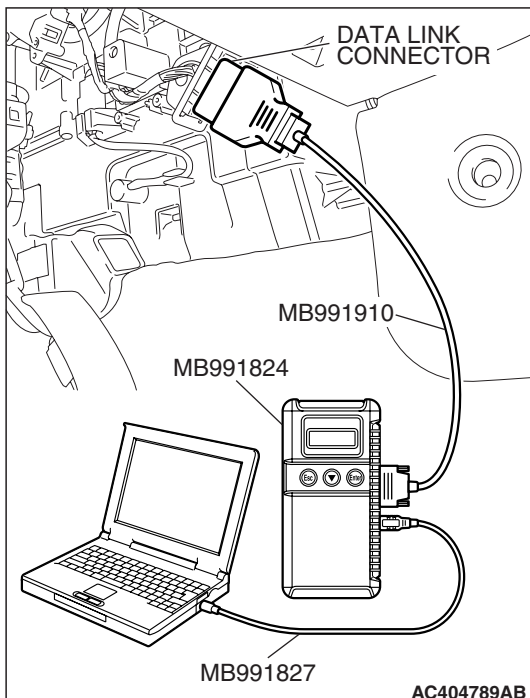

STEP 3. Using scan tool MB991958, check data list.

⚠ CAUTION

To prevent damage to scan tool MB991958, always turn the ignition switch to the "LOCK" (OFF) position before connecting or disconnecting scan tool MB991958.

- (1) Connect scan tool MB991958 to the data link connector.
- (2) Start the engine.
- (3) Set scan tool MB991958 to the data reading mode, and check the data list items by driving the vehicle (Refer to P.35B-131).
 - Item 02: Front left wheel speed sensor
- (4) Turn the ignition switch to the "LOCK" (OFF) position.

Q: Does the speedometer indication match the scan tool indication?

YES : It can be assumed that this malfunction is intermittent. Refer to GROUP 00, How to Use Troubleshooting/Inspection Service Points –How to Cope with Intermittent Malfunction P.00-14.

NO : Go to Step 4.

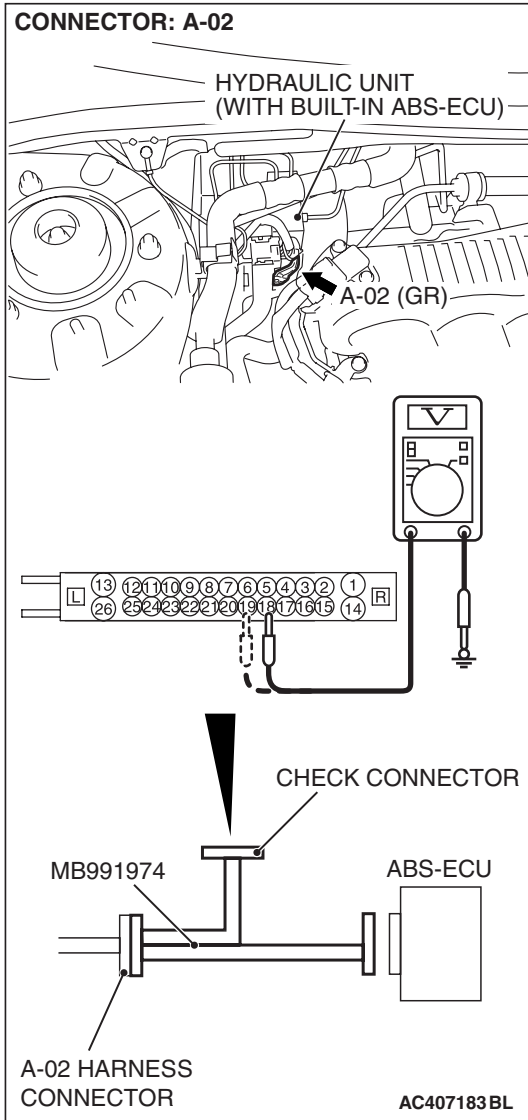

STEP 4. Measure the voltage at ABS-ECU connector A-02.

- (1) Disconnect the connector A-02, and connect special tool MB991974 to the wiring harness-side connector.

NOTE: Do not connect special tool MB991974 to the ABS-ECU.

- (2) Turn the ignition switch to the "ON" position.
- (3) Measure the voltage between terminal 18 and body ground, and between terminal 19 and body ground. It should be 1V or less.

Q: Does the voltage measure 1 V or less?

YES : Go to Step 5.

NO : Go to Step 7.

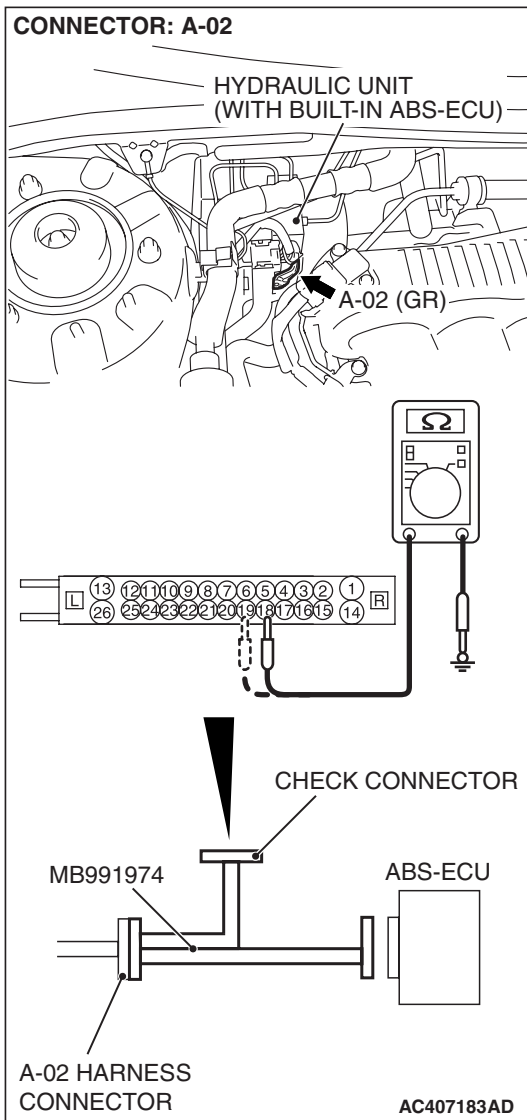

STEP 5. Measure the resistance at ABS-ECU connector A-02.

(1) Disconnect the connector A-02, and connect special tool MB991974 to the wiring harness-side connector.

NOTE: Do not connect special tool MB991974 to the ABS-ECU.

(2) Measure the resistance between terminal 18 and body ground, and between terminal 19 and body ground. There should be no continuity.

Q: Does continuity exist?

YES : Go to Step 7.

NO : Go to Step 6.

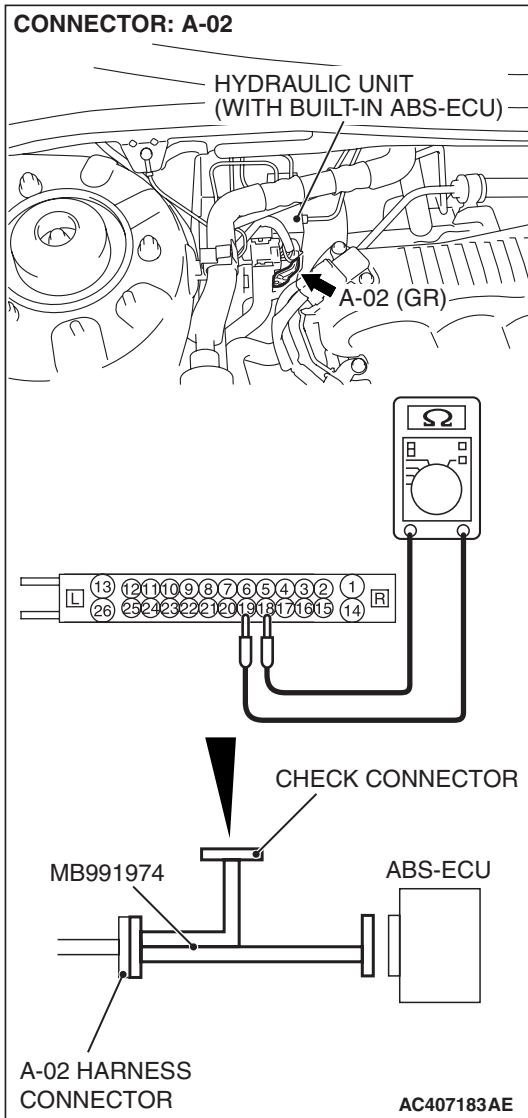

STEP 6. Measure the resistance at the ABS-ECU connector A-02.

(1) Disconnect the connector A-02, and connect special tool MB991974 to the wiring harness-side connector.

NOTE: Do not connect special tool ABS Check Harness MB991974 to the ABS-ECU.

(2) Measure the resistance between the ABS-ECU connector terminals 18 and 19.

Standard Value: 1.24 – 1.64 kΩ

Q: Is the resistance between terminals 18 and 19 within the standard value?

YES : Go to Step 10.

NO : Go to Step 7.

STEP 7. Check ABS-ECU connector A-02 and wheel speed sensor <front: LH> connector A-06 for loose, corroded or damaged terminals, or terminals pushed back in the connector.

Q: Are ABS-ECU connector A-02 and wheel speed sensor <front: LH> connector A-06 damaged?

YES : Repair or replace the damaged component(s). Refer to GROUP 00E, Harness Connector Inspection

P.00E-2. Then go to Step 11.

NO : Go to Step 8.

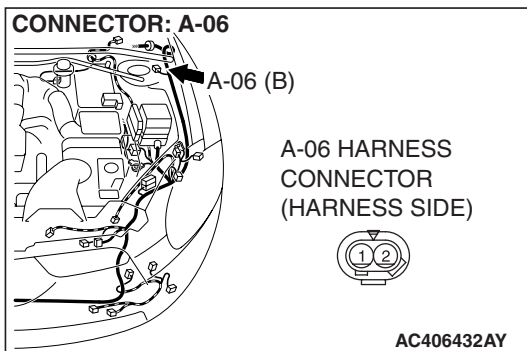
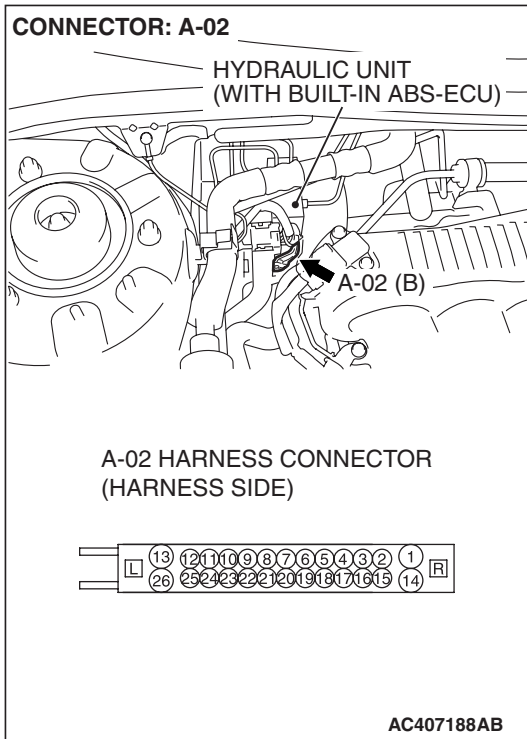

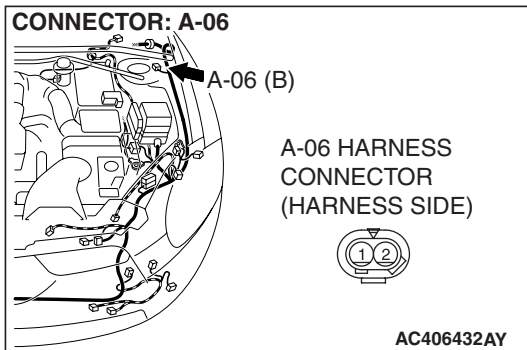
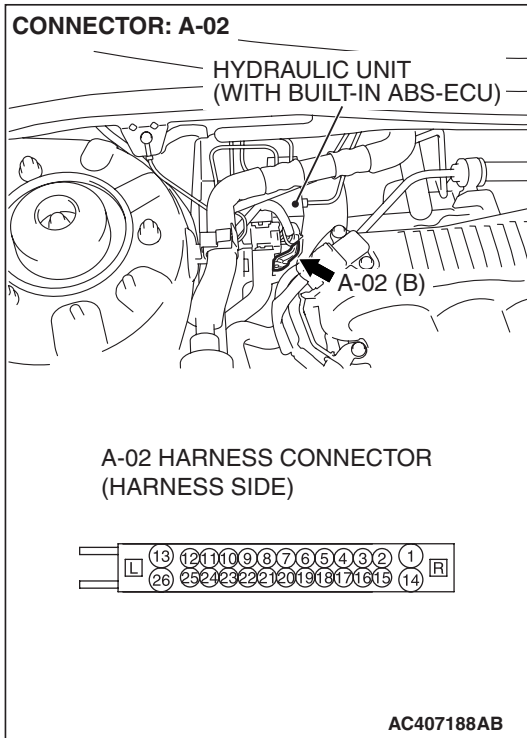

STEP 8. Check the harness wires between ABS-ECU connector A-02 (terminal 18, 19) and wheel speed sensor connector A-06 (terminal 1, 2).

Q: Is the harness wire between ABS-ECU connector A-02 (terminal 18, 19) and wheel speed sensor connector A-06 (terminal 1, 2) damaged?

YES : Repair the wiring harness. Then go to Step 11.

NO : Go to Step 9.

STEP 9. Inspect the wheel speed sensor.

Check the front left wheel speed sensor relevant to the DTC code. For the applicable inspection procedure, refer to [P.35B-146](#).

Q: Is the wheel speed sensor damaged?

YES : Replace the wheel speed sensor. Then go to Step 11.

NO : It can be assumed that this malfunction is intermittent.

Refer to GROUP 00, How to Use Troubleshooting/Inspection Service Points –How to Cope with Intermittent Malfunction [P.00-14](#).

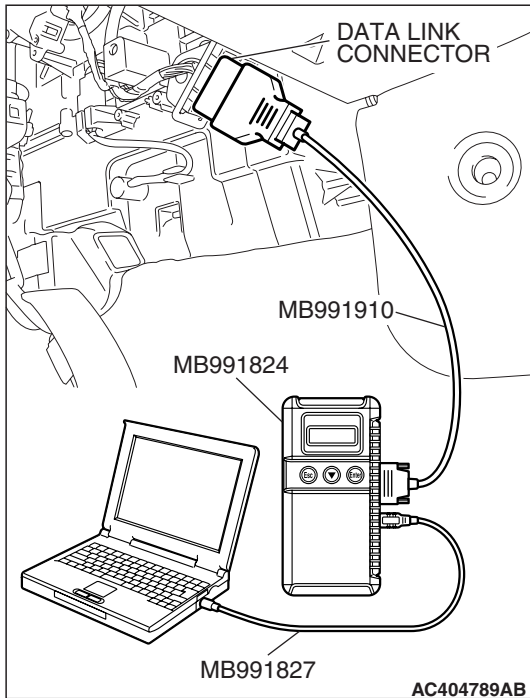

STEP 10. Recheck for diagnostic trouble code.

⚠ CAUTION

To prevent damage to scan tool MB991958, always turn the ignition switch to the "LOCK" (OFF) position before connecting or disconnecting scan tool MB991958.

Check again if the DTC is set.

- (1) Turn the ignition switch to the "ON" position.
- (2) Erase the DTC.
- (3) Turn the ignition switch to the "LOCK" (OFF) position.
- (4) Turn the ignition switch to the "ON" position.
- (5) Check if the DTC is reset.
- (6) Turn the ignition switch to the "LOCK" (OFF) position.

Q: Is DTC C1205 set?

YES : Replace the hydraulic unit (integrated with ABS-ECU). Then go to Step 11.

NO : It can be assumed that this malfunction is intermittent. Refer to GROUP 00, How to Use Troubleshooting/Inspection Service Points –How to Cope with Intermittent Malfunction P.00-14.

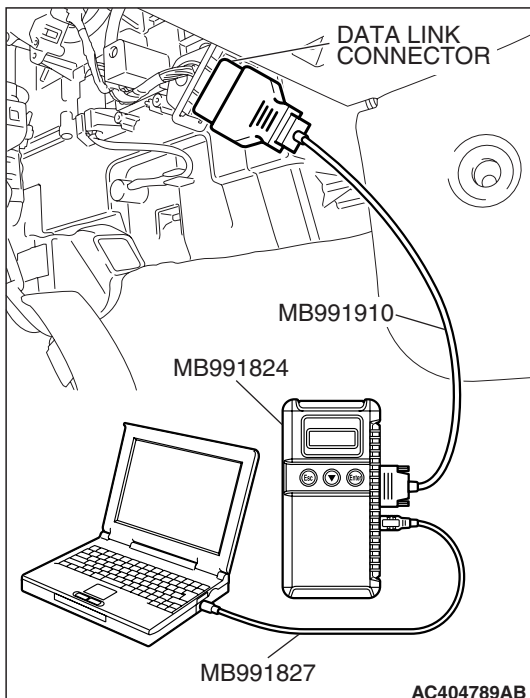

STEP 11. Recheck for diagnostic trouble code.

⚠ CAUTION

To prevent damage to scan tool MB991958, always turn the ignition switch to the "LOCK" (OFF) position before connecting or disconnecting scan tool MB991958.

- (1) Turn the ignition switch to the "ON" position.
- (2) Erase the DTC.
- (3) Turn the ignition switch to the "LOCK" (OFF) position.
- (4) Turn the ignition switch to the "ON" position.
- (5) Check if the DTC is set.
- (6) Turn the ignition switch to the "LOCK" (OFF) position.

Q: Is DTC C1205 set?

YES : Repeat the troubleshooting from Step 1.

NO : The procedure is complete.

DTC C1206: Front Left Wheel Speed Sensor (Abnormal Output Signal)

Wheel Speed Sensor Circuit

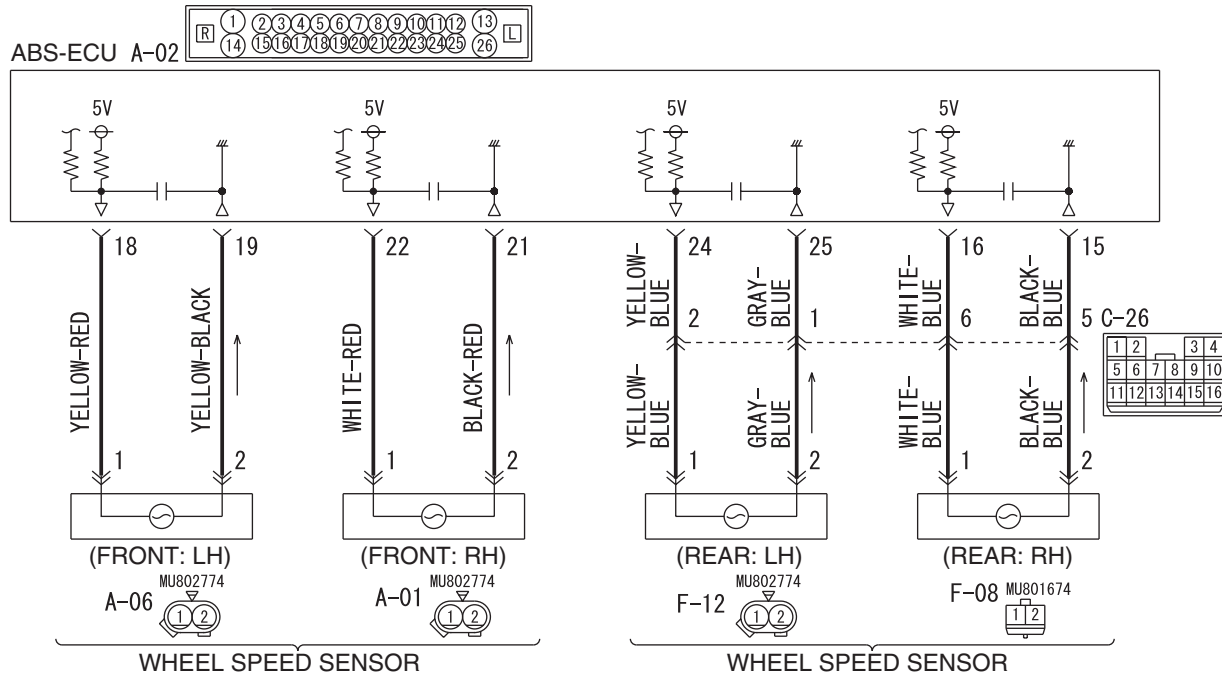

W6P35M000A

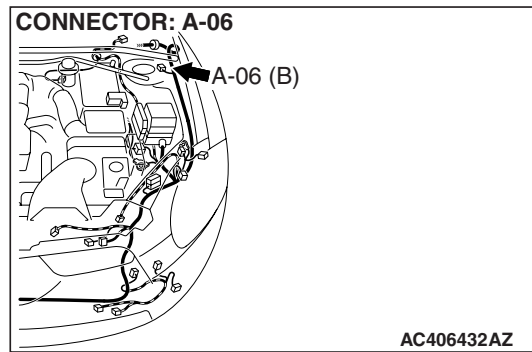
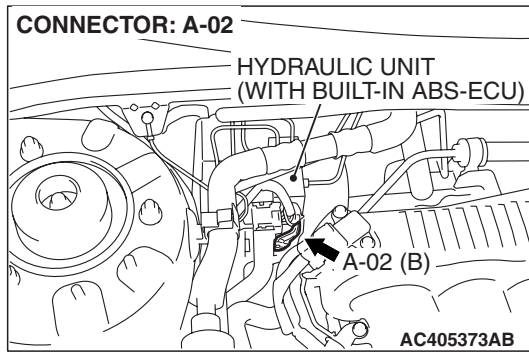

CAUTION

If there is any problem in the CAN bus lines, an incorrect diagnostic trouble code may be set. Prior to this diagnosis, diagnose the CAN bus lines. (Refer to GROUP 54C, Trouble code diagnosis P.54C-12).

CIRCUIT OPERATION

- A toothed wheel speed rotor generates a voltage pulse as it moves across the pickup field of each wheel speed sensor.

- The amount of voltage generated at each wheel is determined by the clearance between the wheel speed rotor teeth and the wheel speed sensor, and by the speed of rotation.
- Sends alternating current signals at frequencies which are proportional to the rotation speeds of each wheel to the ABS electronic control unit (ABS-ECU).
- The ABS hydraulic unit modulates the amount of braking force individually applied to each wheel cylinder.

ABS DTC SET CONDITIONS

The ABS-ECU monitors the signals from each wheel speed sensor while the vehicle is being driven. If any fault below is found in these sensor signals, the ECU will set the relevant diagnostic trouble code.

- Missing sensor signal
- Sensor signal, which will not be created under normal operation
- Significant difference among the wheel speed sensor signals

TROUBLESHOOTING HINTS (THE MOST LIKELY CAUSES FOR THESE DTCS ARE TO SET ARE:)

Current trouble

- Malfunction of the wheel speed sensor or wheel speed rotor
- Damaged wiring harness or connector
- Malfunction of the hydraulic unit (integrated with ABS-ECU)

Past trouble

- Carry out diagnosis with particular emphasis on connector(s) or wiring harness in wheel speed sensor circuit. For diagnosis procedures, refer to "How to treat past trouble" (Refer to GROUP 00, How to treat past trouble [P.00-16](#)).

DIAGNOSIS

Required Special Tools:

- MB991958: Scan Tool (MUT-III Sub Assembly)
 - MB991824: V.C.I.
 - MB991827: MUT-III USB Cable
 - MB991910: MUT-III Main Harness A
- MB991974: ABS Check Harness

STEP 1. Using scan tool MB991958, diagnose the CAN bus line.

CAUTION

To prevent damage to scan tool MB991958, always turn the ignition switch to the "LOCK" (OFF) position before connecting or disconnecting scan tool MB991958.

- (1) Connect scan tool MB991958 to the data link connector.
- (2) Turn the ignition switch to the "ON" position.
- (3) Diagnose the CAN bus line.
- (4) Turn the ignition switch to the "LOCK" (OFF) position.

Q: Is the CAN bus line found to be normal?

YES : Go to Step 3

NO : Repair the CAN bus line (Refer to GROUP 54C, Diagnosis [P.54C-14](#)). Then go to Step 2.

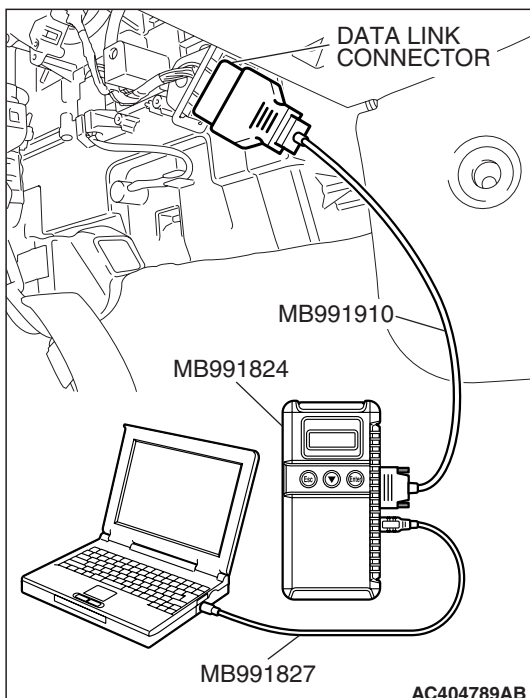

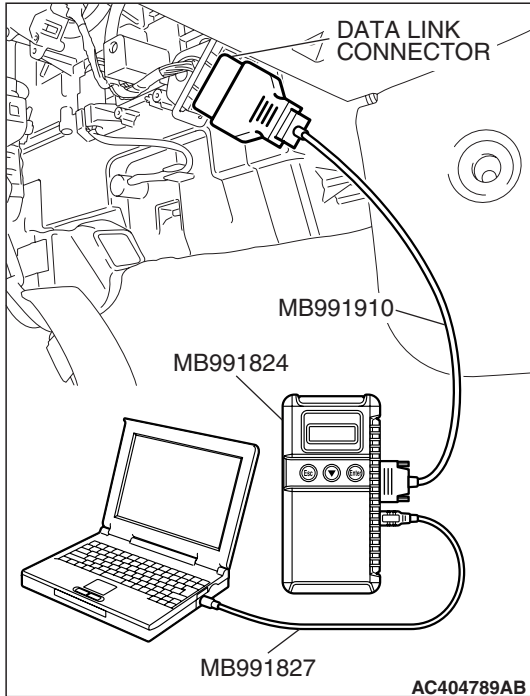
**STEP 2. Recheck for diagnostic trouble code.****⚠ CAUTION**

To prevent damage to scan tool MB991958, always turn the ignition switch to the "LOCK" (OFF) position before connecting or disconnecting scan tool MB991958.

- (1) Turn the ignition switch to the "ON" position.
- (2) Erase the DTC.
- (3) Turn the ignition switch to the "LOCK" (OFF) position.
- (4) Turn the ignition switch to the "ON" position.
- (5) Check if the DTC is set.
- (6) Turn the ignition switch to the "LOCK" (OFF) position.

Q: Is DTC C1206 set?

YES : Go to Step 3

NO : The procedure is complete.

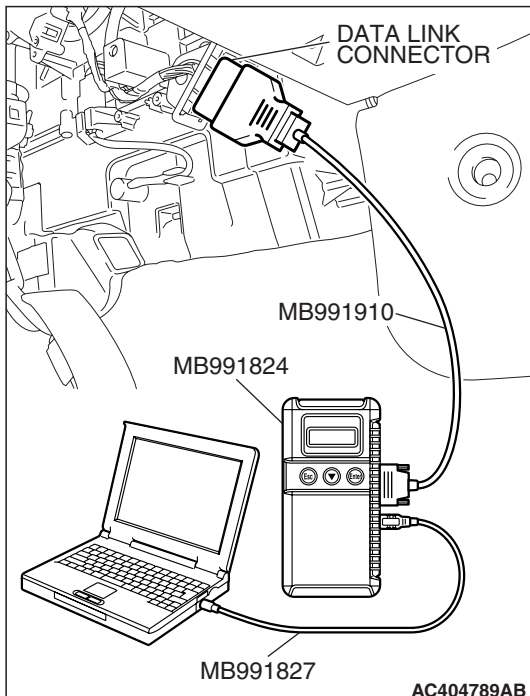
**STEP 3. Using scan tool MB991958, read the diagnostic trouble code.****⚠ CAUTION**

To prevent damage to scan tool MB991958, always turn the ignition switch to the "LOCK" (OFF) position before connecting or disconnecting scan tool MB991958.

Use scan tool MB991958 to check whether DTC code C1205 have been set simultaneously.

- (1) Connect scan tool MB991958 to the data link connector.
- (2) Turn the ignition switch to the "ON" position.
- (3) Check whether DTC C1205 have been set.
- (4) Turn the ignition switch to the "LOCK" (OFF) position.

Q: Is DTC C1205 set?

YES : Carry out diagnosis relevant to DTC C1205 (Refer to [P.35B-29](#)).

NO : Go to Step 4.

STEP 4. Check the installation condition of the wheel speed sensors.

For the wheel speed sensor, which the DTC code indicates, check whether the sensor or its mounting bolts are loosened.

- DTC C1206 is set: Front left wheel speed sensor

Q: Is the wheel speed sensor installed correctly?

YES : Go to Step 5.

NO : Reinstall the wheel speed sensor correctly. Then go to Step 13.

STEP 5. Check the wheel speed sensor after it is removed from the vehicle.

Check the wheel speed sensor which the DTC code indicates (Refer to [P.35B-146](#)).

- DTC C1206 is set: Front left wheel speed sensor

Q: Is the wheel speed sensor in good condition?

YES : Go to Step 6.

NO : Replace the wheel speed sensor (Refer to [P.35C-164](#)). Then go to Step 13.

STEP 6. Check the wheel bearing for looseness.

NOTE: If the wheel bearing is loose, the gap between the wheel speed sensor and rotor may become excessive. Check the wheel bearing, which DTC code indicates, for looseness.

- DTC C1206 is set: Check the front right wheel bearing (Refer to GROUP 26, On-vehicle service –Wheel bearing end play check [P.26-8](#)).

Q: Is the wheel bearing end play within the standard value?

YES : Go to Step 7.

NO : Replace the front hub assembly (Refer to GROUP 26, Front axle hub assembly [P.26-9](#)).

STEP 7. Check the wheel speed rotor.

Check the wheel speed rotor, which DTC code indicates, for foreign material or deformation.

- DTC C1206 is set: Front left wheel speed sensor

Q: Is the wheel speed rotor in good condition?

YES : Go to Step 8.

NO : If the wheel speed rotor is contaminated with foreign material, clean it. If the driveshaft is deformed, replace it (Refer to GROUP 26, Drive shaft assembly [P.26-14](#)).

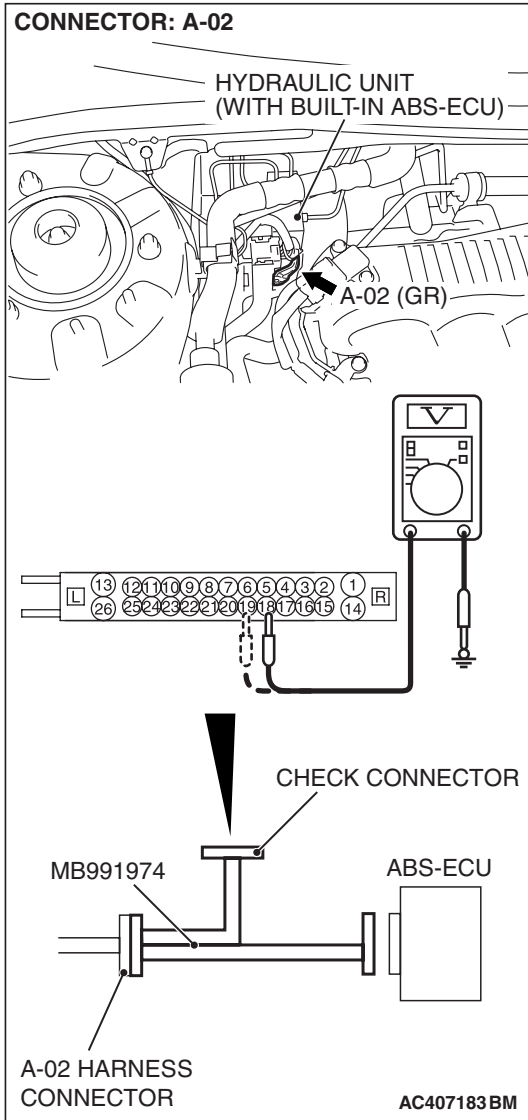

STEP 8. Measure the voltage at ABS-ECU connector A-02.

- (1) Disconnect the connector A-02, and connect special tool MB991974 to the wiring harness-side connector.

NOTE: Do not connect special tool MB991974 to the ABS-ECU.

- (2) Turn the ignition switch to the "ON" position.
- (3) Measure the voltage between terminal 18 and body ground, and between terminal 19 and body ground. It should be 1V or less.

Q: Does the voltage measure 1 V or less?

- YES :** Go to Step 9.
NO : Go to Step 11.

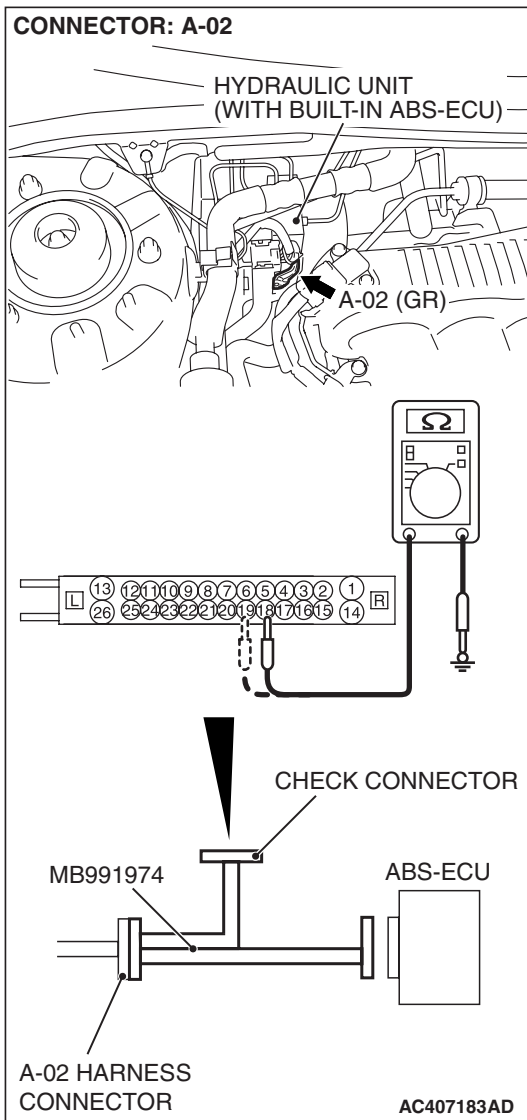

STEP 9. Measure the resistance at ABS-ECU connector A-02.

- (1) Disconnect the connector A-02, and connect special tool MB991974 to the wiring harness-side connector.

NOTE: Do not connect special tool MB991974 to the ABS-ECU.

- (2) Measure the resistance between terminal 18 and body ground, and between terminal 19 and body ground. There should be no continuity.

Q: Does continuity exist?

YES : Go to Step 11.

NO : Go to Step 10.

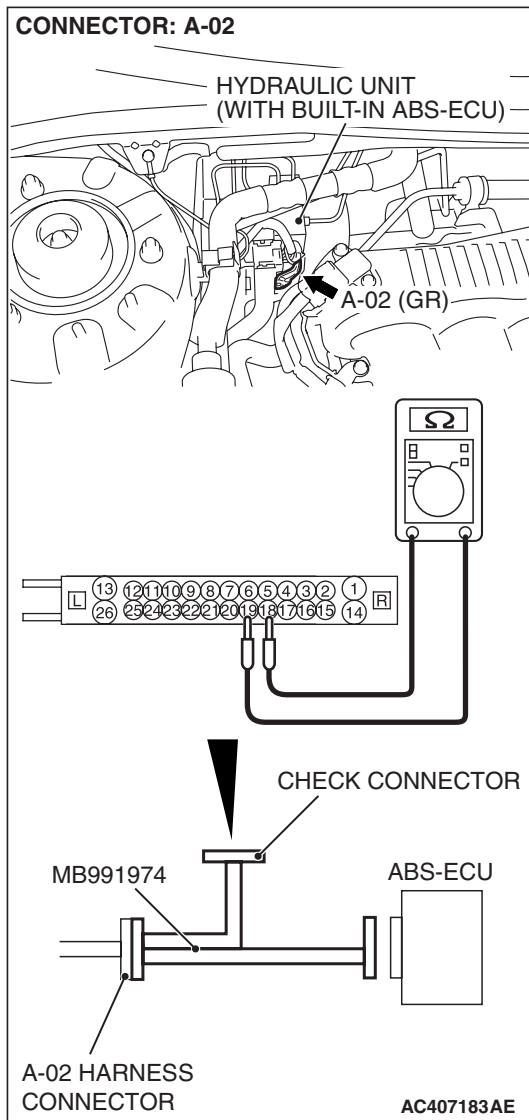

STEP 10. Measure the resistance at ABS-ECU connector A-02.

- (1) Disconnect the connector A-02, and connect special tool MB991974 to the wiring harness-side connector.

NOTE: Do not connect special tool MB991974 to the ABS-ECU.

- (2) Measure the resistance between terminal 18 and terminal 19.

Standard Value: 1.24 – 1.64 kΩ

Q: Is the resistance between terminals 18 and 19 within the standard value?

YES : Go to Step 12.

NO : Go to Step 11.

STEP 11. Check ABS-ECU connector A-02 and wheel speed sensor <front: LH> connector A-06 for loose, corroded or damaged terminals, or terminals pushed back in the connector.

Q: Are ABS-ECU connector A-02 and wheel speed sensor <front: LH> connector A-06 damaged?

YES : Repair or replace the damaged component(s). Refer to GROUP 00E, Harness Connector Inspection **P.00E-2**. Then go to Step 13.

NO : Open or short circuit may be present in the front right wheel speed sensor circuit. Repair the wiring harness between ABS-ECU connector A-02 (terminals 18 and 19) and front left wheel speed sensor A-06 (terminals 1 and 2). Then go to Step 13.

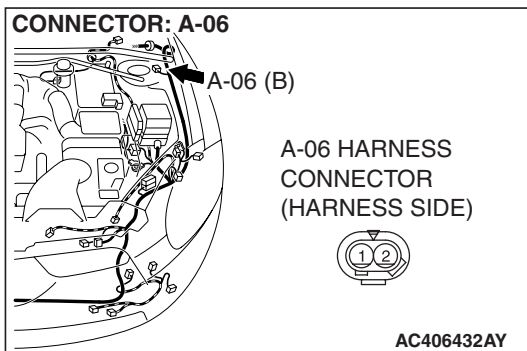
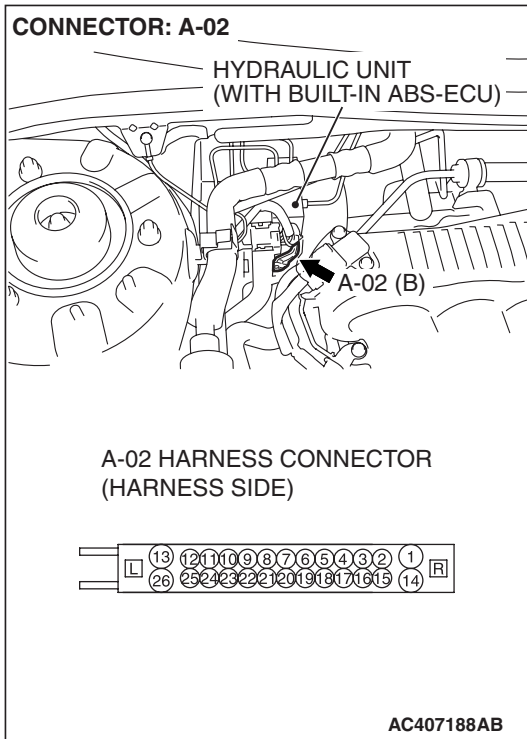

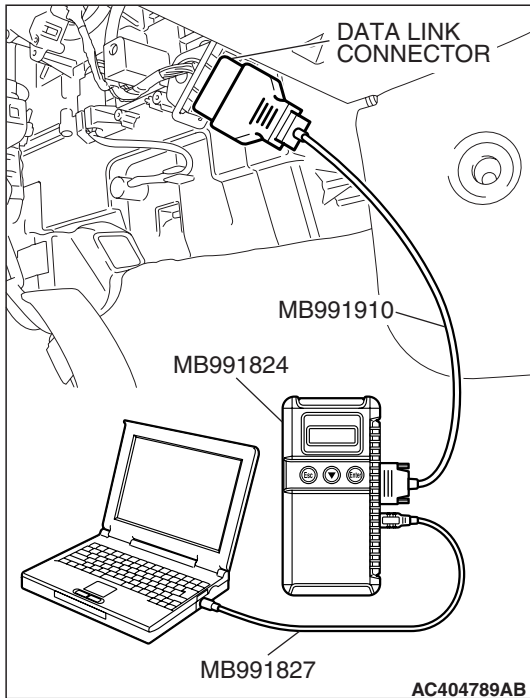
**STEP 12. Recheck for diagnostic trouble code.****⚠ CAUTION**

To prevent damage to scan tool MB991958, always turn the ignition switch to the "LOCK" (OFF) position before connecting or disconnecting scan tool MB991958.

Check again if the DTC is set.

- (1) Turn the ignition switch to the "ON" position.
- (2) Erase the DTC.
- (3) Turn the ignition switch to the "LOCK" (OFF) position.
- (4) Turn the ignition switch to the "ON" position.
- (5) Check if the DTC is set.
- (6) Turn the ignition switch to the "LOCK" (OFF) position.

Q: Is DTC C1206 set?

YES : Replace the hydraulic unit (integrated with ABS-ECU). Then go to Step 13.

NO : It can be assumed that this malfunction is intermittent. Refer to GROUP 00, How to Use Troubleshooting/Inspection Service Points –How to Cope with Intermittent Malfunction [P.00-14](#).

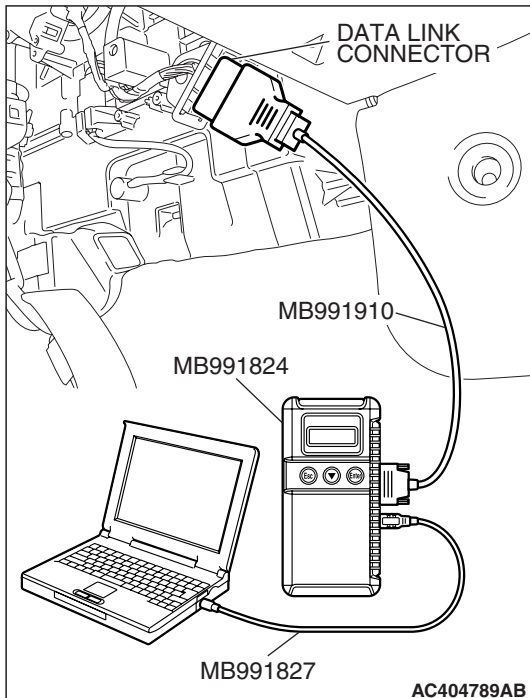
**STEP 13. Recheck for diagnostic trouble code.****⚠ CAUTION**

To prevent damage to scan tool MB991958, always turn the ignition switch to the "LOCK" (OFF) position before connecting or disconnecting scan tool MB991958.

Check again if the DTC is set.

- (1) Turn the ignition switch to the "ON" position.
- (2) Erase the DTC.
- (3) Turn the ignition switch to the "LOCK" (OFF) position.
- (4) Turn the ignition switch to the "ON" position.
- (5) Check if the DTC is set.
- (6) Turn the ignition switch to the "LOCK" (OFF) position.

Q: Is DTC C1206 set?

YES : Go to Step 1.

NO : The procedure is complete.

DTC C1210: Rear Right Wheel Speed Sensor (Open Circuit or Short Circuit)

Wheel Speed Sensor Circuit

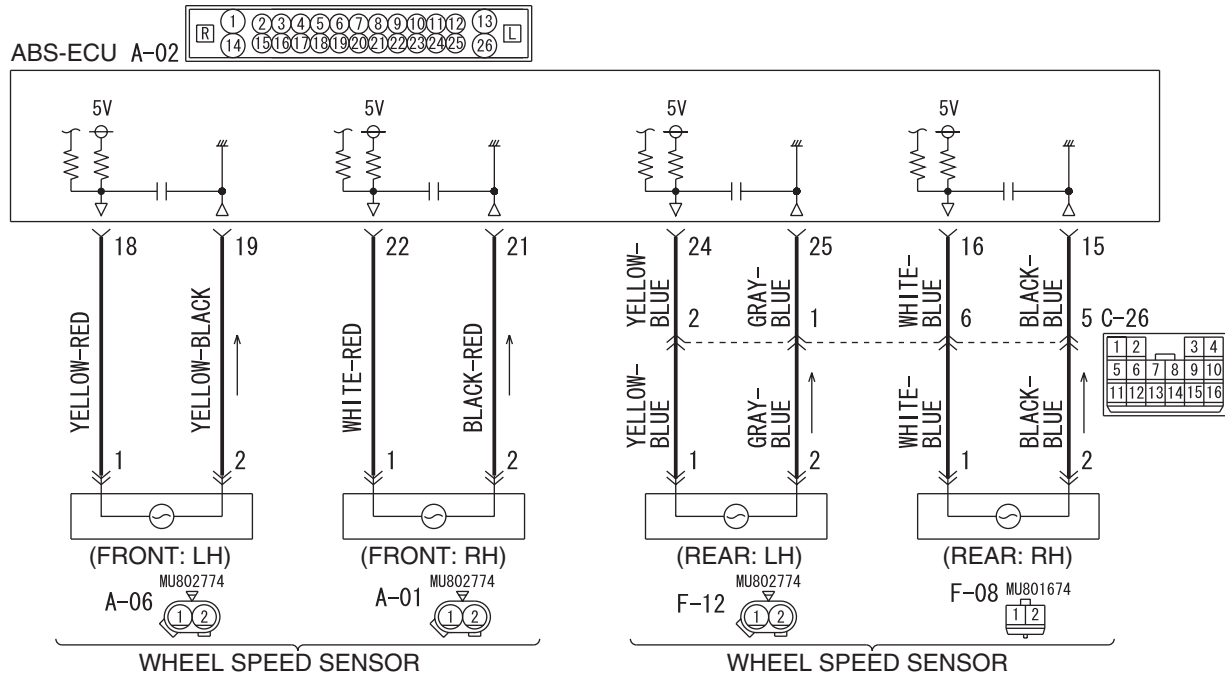

W6P35M000A

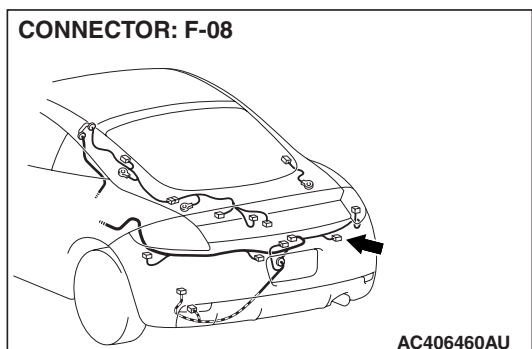
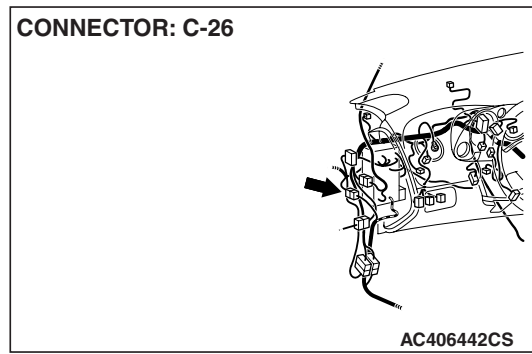
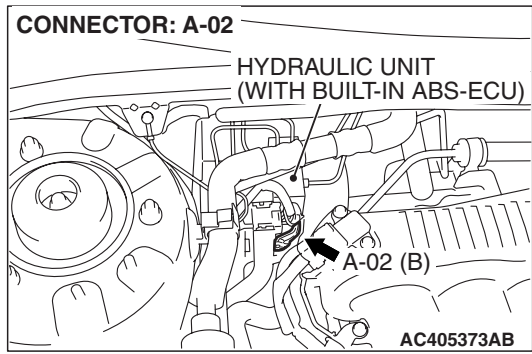

CAUTION
If there is any problem in the CAN bus lines, an incorrect diagnostic trouble code may be set. Prior to this diagnosis, diagnose the CAN bus

lines. (Refer to GROUP 54C, Trouble code diagnosis P.54C-12).

CIRCUIT OPERATION

- A toothed wheel speed rotor generates a voltage pulse as it moves across the pickup field of each wheel speed sensor.
- The amount of voltage generated at each wheel is determined by the clearance between the wheel speed rotor teeth and the wheel speed sensor, and by the speed of rotation.
- Sends alternating current signals at frequencies which are proportional to the rotation speeds of each wheel to the ABS electronic control unit (ABS-ECU).
- The ABS hydraulic unit modulates the amount of braking force individually applied to each wheel cylinder.

ABS DTC SET CONDITIONS

The ABS-ECU monitors voltage fluctuation in each wheel speed sensor circuit. If the ECU detects a short or open circuit in the circuit, it will set a diagnostic trouble code.

TROUBLESHOOTING HINTS (THE MOST LIKELY CAUSES FOR THESE DTCS ARE TO SET ARE:)**Current trouble**

- Malfunction of the wheel speed sensor
- Damaged wiring harness or connector
- Malfunction of the hydraulic unit (integrated with ABS-ECU)

Past trouble

- Carry out diagnosis with particular emphasis on connector(s) or wiring harness in wheel speed sensor circuit. For diagnosis procedures, refer to "How to treat past trouble" (Refer to GROUP 00, How to treat past trouble [P.00-16](#)).

DIAGNOSIS**Required Special Tools:**

- MB991958: Scan Tool (MUT-III Sub Assembly)
 - MB991824: V.C.I.
 - MB991827: MUT-III USB Cable
 - MB991910: MUT-III Main Harness A
- MB991974: ABS Check Harness

STEP 1. Using scan tool MB991958, diagnose the CAN bus line.

⚠ CAUTION

To prevent damage to scan tool MB991958, always turn the ignition switch to the "LOCK" (OFF) position before connecting or disconnecting scan tool MB991958.

- (1) Connect scan tool MB991958 to the data link connector.
- (2) Turn the ignition switch to the "ON" position.
- (3) Diagnose the CAN bus line.
- (4) Turn the ignition switch to the "LOCK" (OFF) position.

Q: Is the CAN bus line found to be normal?

YES : Go to Step 3

NO : Repair the CAN bus line (Refer to GROUP 54C, Diagnosis P.54C-14). Then go to Step 2.

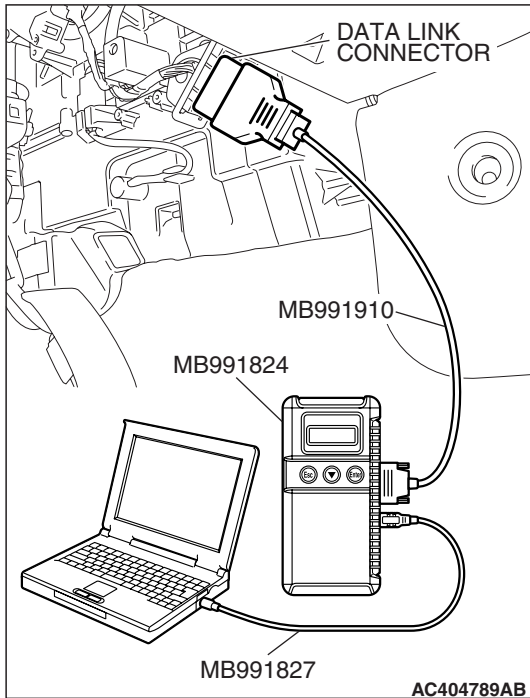

STEP 2. Recheck for diagnostic trouble code.

⚠ CAUTION

To prevent damage to scan tool MB991958, always turn the ignition switch to the "LOCK" (OFF) position before connecting or disconnecting scan tool MB991958.

- (1) Turn the ignition switch to the "ON" position.
- (2) Erase the DTC.
- (3) Turn the ignition switch to the "LOCK" (OFF) position.
- (4) Turn the ignition switch to the "ON" position.
- (5) Check if the DTC is set.
- (6) Turn the ignition switch to the "LOCK" (OFF) position.

Q: Is DTC C1210 set?

YES : Go to Step 3

NO : The procedure is complete.

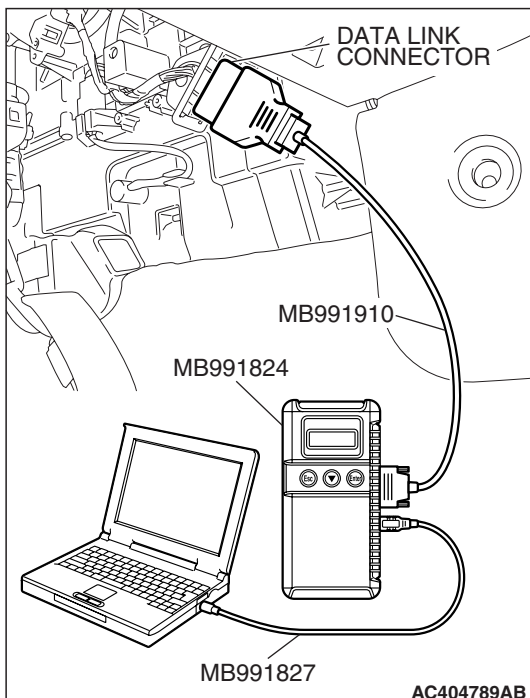

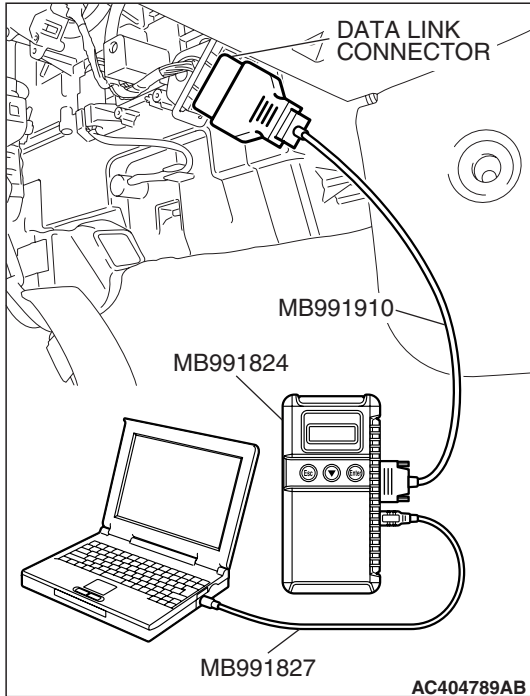
**STEP 3. Using scan tool MB991958, check data list.****⚠ CAUTION**

To prevent damage to scan tool MB991958, always turn the ignition switch to the "LOCK" (OFF) position before connecting or disconnecting scan tool MB991958.

- (1) Connect scan tool MB991958 to the data link connector.
- (2) Start the engine.
- (3) Set scan tool MB991958 to the data reading mode, and check the data list items by driving the vehicle (Refer to [P.35B-131](#)).
 - Item 03: Rear right wheel speed sensor
- (4) Turn the ignition switch to the "LOCK" (OFF) position.

Q: Does the speedometer indication match the scan tool indication?

YES : It can be assumed that this malfunction is intermittent.

Refer to GROUP 00, How to Use

Troubleshooting/Inspection Service Points –How to Cope with Intermittent Malfunction [P.00-14](#).

NO : Go to Step 4.

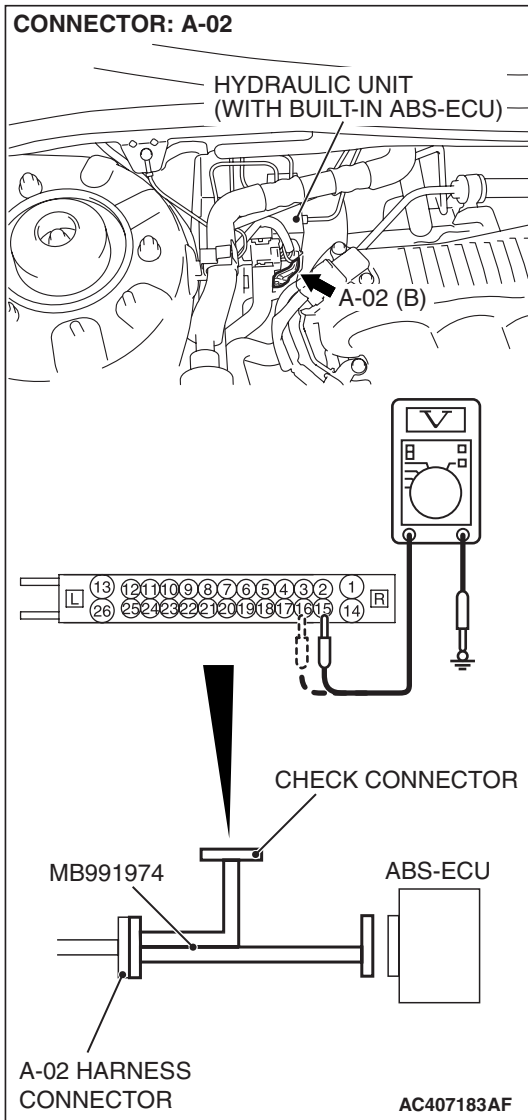

STEP 4. Measure the voltage at ABS-ECU connector A-02.

- (1) Disconnect the connector A-02, and connect special tool MB991974 to the wiring harness-side connector.

NOTE: Do not connect special tool MB991974 to the ABS-ECU.

- (2) Turn the ignition switch to the "ON" position.
- (3) Measure the voltage between terminal 15 and body ground, and between terminal 16 and body ground. It should be 1V or less.

Q: Does the voltage measure 1 V or less?

YES : Go to Step 5.

NO : Go to Step 7.

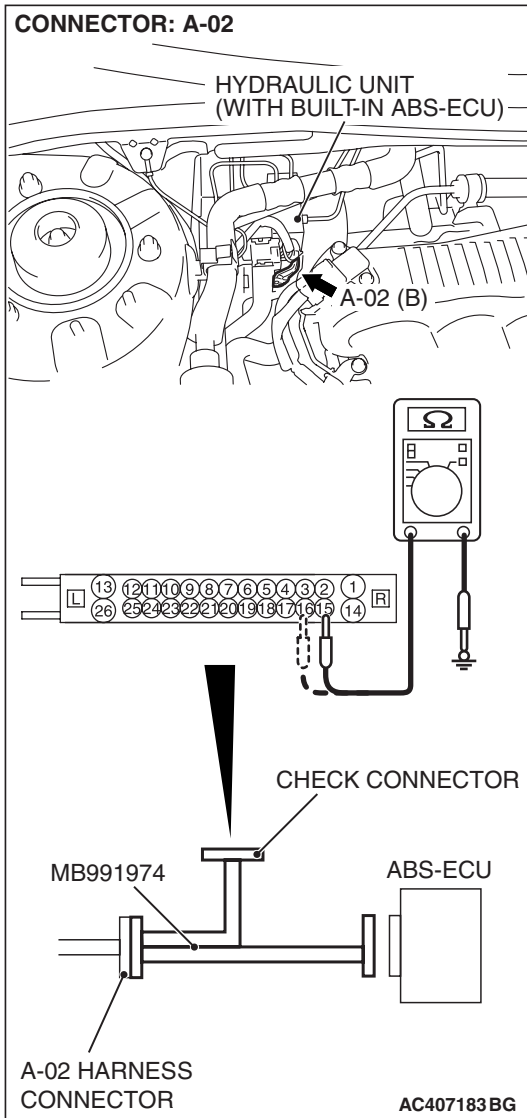

STEP 5. Measure the resistance at ABS-ECU connector A-02.

(1) Disconnect the connector A-02, and connect special tool MB991974 to the wiring harness-side connector.

NOTE: Do not connect special tool MB991974 to the ABS-ECU.

(2) Measure the resistance between terminal 15 and body ground, and between terminal 16 and body ground. There should be no continuity.

Q: Does continuity exist?

YES : Go to Step 7.

NO : Go to Step 6.

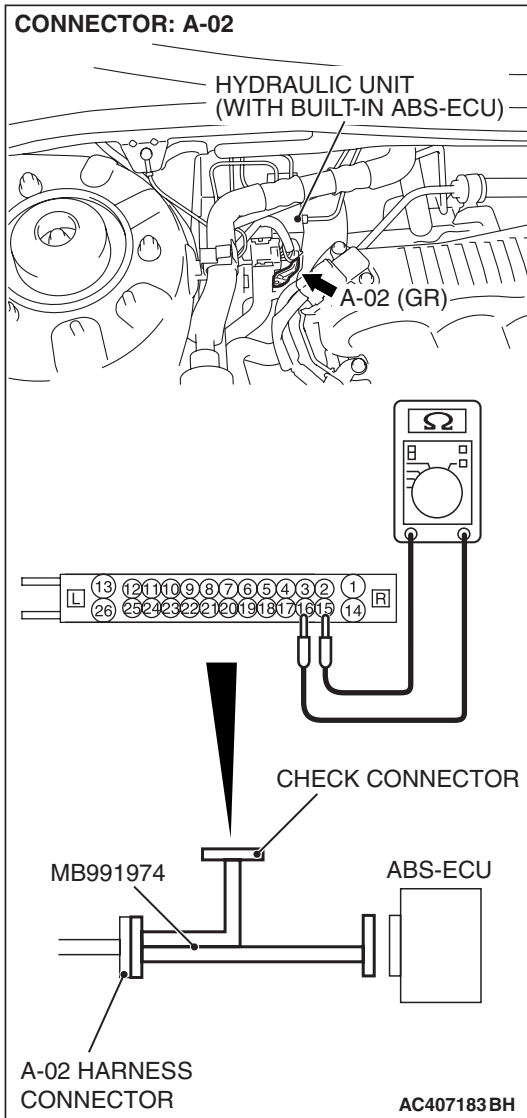

STEP 6. Measure the resistance at the ABS-ECU connector A-02.

(1) Disconnect the connector A-02, and connect special tool MB991974 to the wiring harness-side connector.

NOTE: Do not connect special tool MB991974 to the ABS-ECU.

(2) Measure the resistance between the ABS-ECU connector terminals 15 and 16.

Standard Value: 1.24 – 1.64 k Ω

Q: Is the resistance between terminals 15 and 16 within the standard value?

YES : Go to Step 10.

NO : Go to Step 7.

STEP 7. Check ABS-ECU connector A-02, intermediate connector C-26 and wheel speed sensor <rear: RH> connector F-08 for loose, corroded or damaged terminals, or terminals pushed back in the connector.

Q: Are ABS-ECU connector A-02, intermediate connector C-26 and wheel speed sensor <rear: RH> connector F-08 damaged?

YES : Repair or replace the damaged component(s). Refer to GROUP 00E, Harness Connector Inspection

P.00E-2. Then go to Step 11.

NO : Go to Step 8.

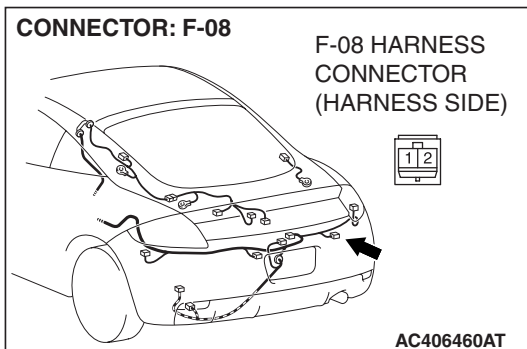
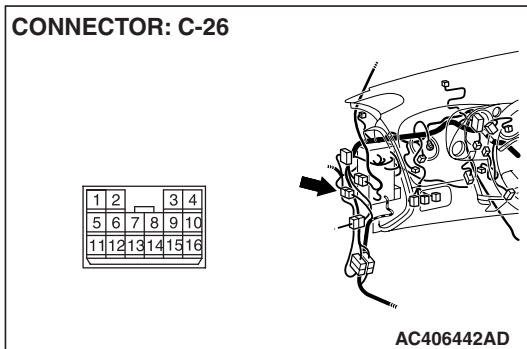
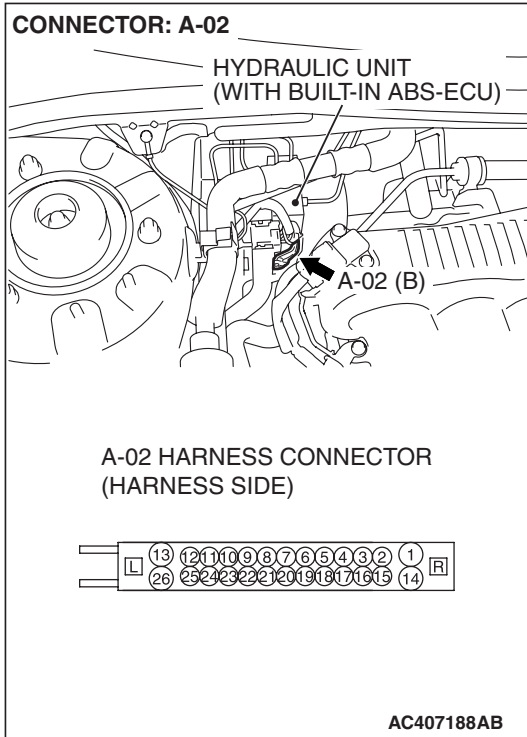

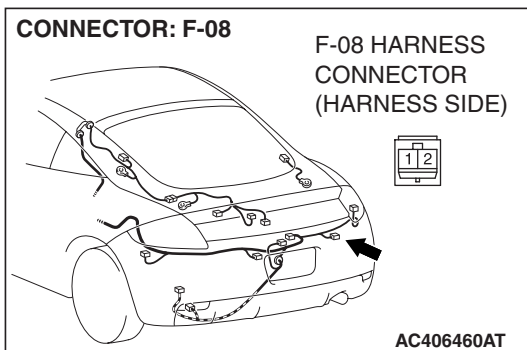
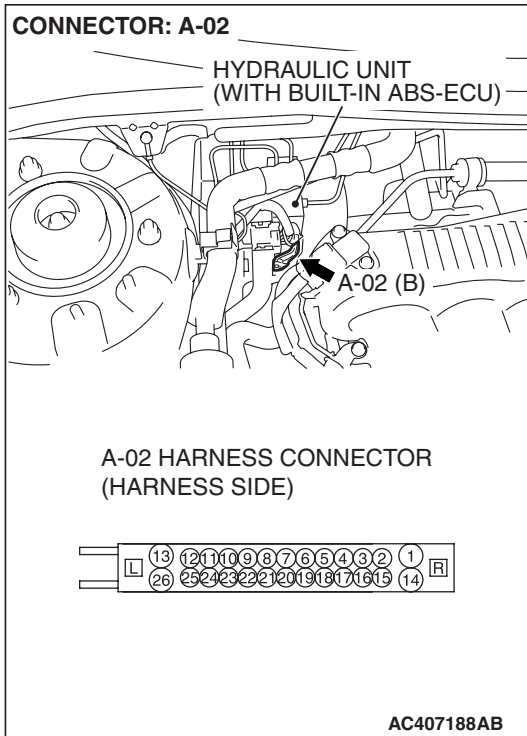

STEP 8. Check the harness wires between ABS-ECU connector A-02 (terminal 15, 16) and wheel speed sensor <rear: RH> connector F-08 (terminal 2, 1).

Q: Is the harness wire between ABS-ECU connector A-02 (terminal 15, 16) and wheel speed sensor <rear: RH> connector F-08 (terminal 2, 1) damaged?

YES : Repair the wiring harness. Then go to Step 11.

NO : Go to Step 9.

STEP 9. Inspect the wheel speed sensor.

Check the wheel speed sensor relevant to the DTC code. For the applicable inspection procedure, refer to [P.35B-146](#).

- When DTC code C1210 is set: Rear right wheel speed sensor

Q: Is the wheel speed sensor damaged?

YES : Replace the wheel speed sensor. Then go to Step 11.

NO : It can be assumed that this malfunction is intermittent. Refer to GROUP 00, How to Use Troubleshooting/Inspection Service Points –How to Cope with Intermittent Malfunction [P.00-14](#).

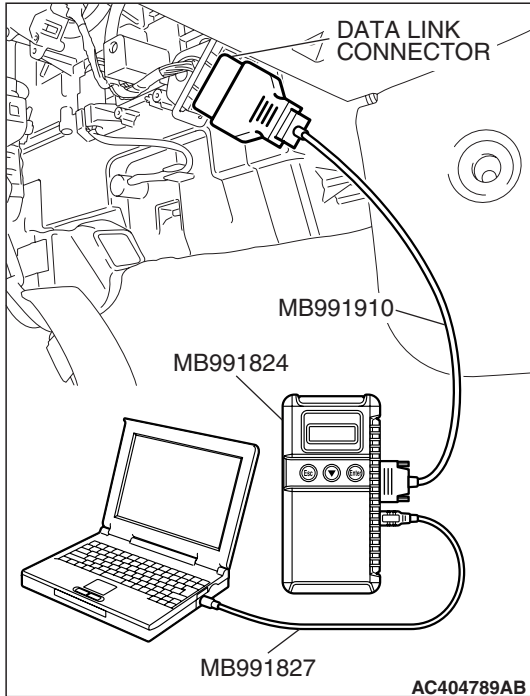
**STEP 10. Recheck for diagnostic trouble code.****⚠ CAUTION**

To prevent damage to scan tool MB991958, always turn the ignition switch to the "LOCK" (OFF) position before connecting or disconnecting scan tool MB991958.

Check again if the DTC is set.

- (1) Turn the ignition switch to the "ON" position.
- (2) Erase the DTC.
- (3) Turn the ignition switch to the "LOCK" (OFF) position.
- (4) Turn the ignition switch to the "ON" position.
- (5) Check if the DTC is reset.
- (6) Turn the ignition switch to the "LOCK" (OFF) position.

Q: Is DTC C1210 set?

YES : Replace the hydraulic unit (integrated with ABS-ECU). Then go to Step 11.

NO : It can be assumed that this malfunction is intermittent. Refer to GROUP 00, How to Use Troubleshooting/Inspection Service Points –How to Cope with Intermittent Malfunction [P.00-14](#).

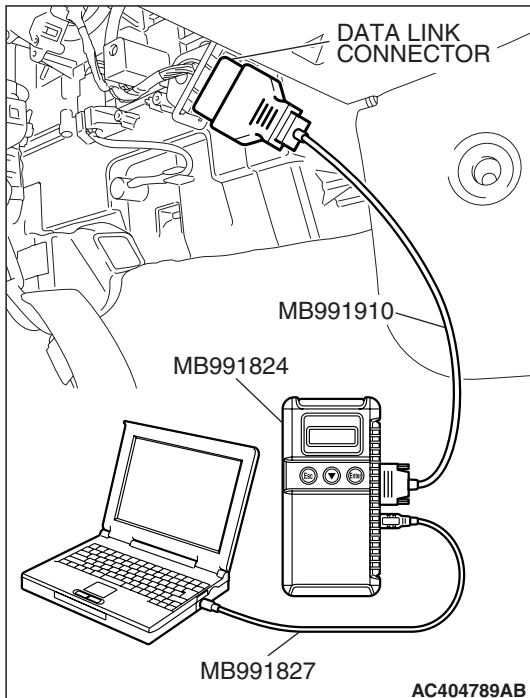
**STEP 11. Recheck for diagnostic trouble code.****⚠ CAUTION**

To prevent damage to scan tool MB991958, always turn the ignition switch to the "LOCK" (OFF) position before connecting or disconnecting scan tool MB991958.

- (1) Turn the ignition switch to the "ON" position.
- (2) Erase the DTC.
- (3) Turn the ignition switch to the "LOCK" (OFF) position.
- (4) Turn the ignition switch to the "ON" position.
- (5) Check if the DTC is set.
- (6) Turn the ignition switch to the "LOCK" (OFF) position.

Q: Is DTC C1210 set?

YES : Repeat the troubleshooting from Step 1.

NO : The procedure is complete.

DTC C1211: Rear Right Wheel Speed Sensor (Abnormal Output Signal)

Wheel Speed Sensor Circuit

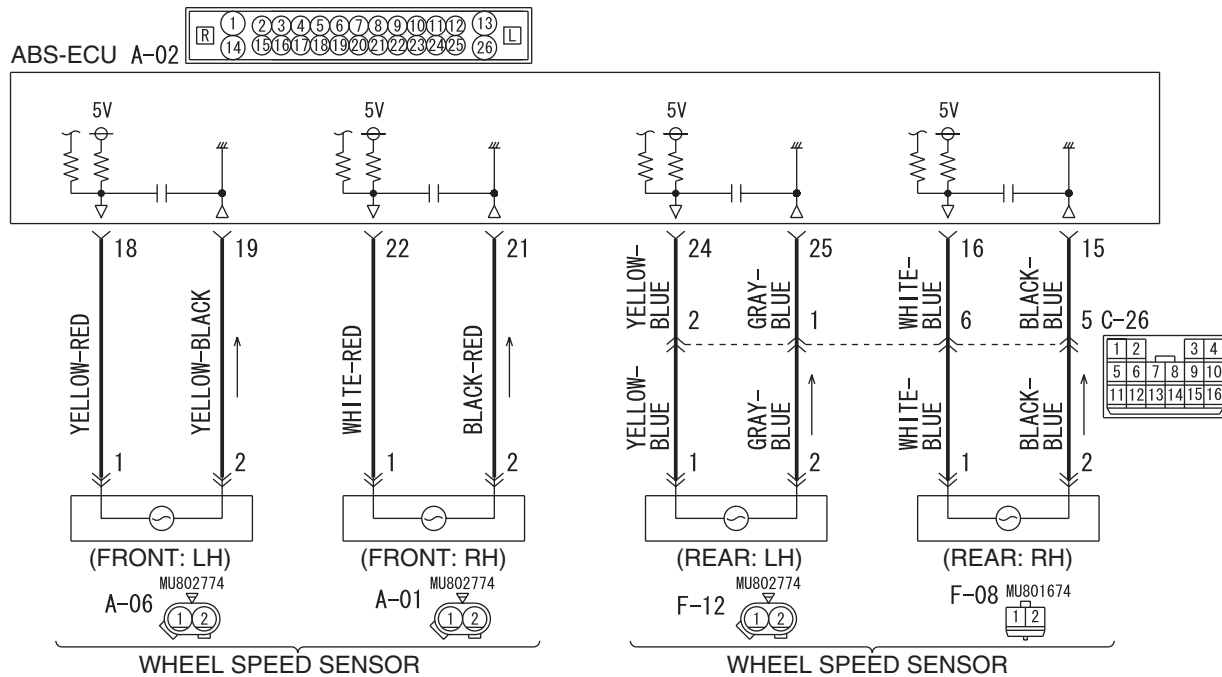

W6P35M000A

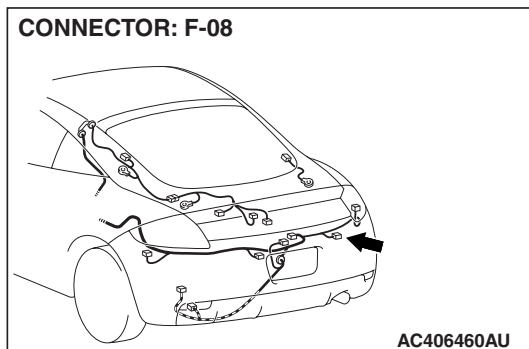
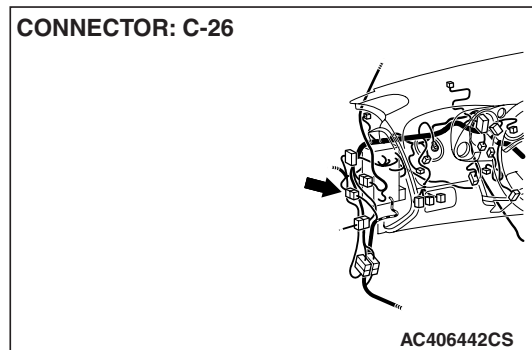
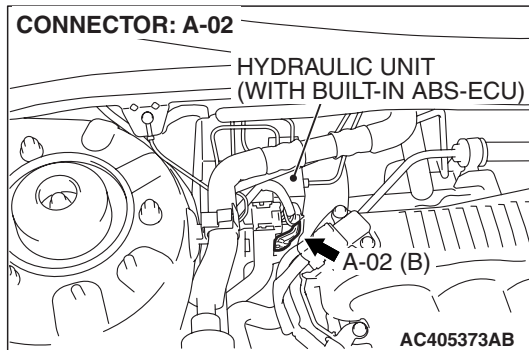

CAUTION

If there is any problem in the CAN bus lines, an incorrect diagnostic trouble code may be set. Prior to this diagnosis, diagnose the CAN bus

lines. (Refer to GROUP 54C, Trouble code diagnosis [P.54C-12](#)).

CIRCUIT OPERATION

- A toothed wheel speed rotor generates a voltage pulse as it moves across the pickup field of each wheel speed sensor.
- The amount of voltage generated at each wheel is determined by the clearance between the wheel speed rotor teeth and the wheel speed sensor, and by the speed of rotation.
- Sends alternating current signals at frequencies which are proportional to the rotation speeds of each wheel to the ABS electronic control unit (ABS-ECU).
- The ABS hydraulic unit modulates the amount of braking force individually applied to each wheel cylinder.

ABS DTC SET CONDITIONS

The ABS-ECU monitors the signals from each wheel speed sensor while the vehicle is being driven. If any fault below is found in these sensor signals, the ECU will set the relevant diagnostic trouble code.

- Missing sensor signal

- Sensor signal, which will not be created under normal operation
- Significant difference among the wheel speed sensor signals

TROUBLESHOOTING HINTS (THE MOST LIKELY CAUSES FOR THESE DTCS ARE TO SET ARE:)**Current trouble**

- Malfunction of the wheel speed sensor or wheel speed rotor
- Damaged wiring harness or connector
- Malfunction of the hydraulic unit (integrated with ABS-ECU)

Past trouble

- Carry out diagnosis with particular emphasis on connector(s) or wiring harness in wheel speed sensor circuit. For diagnosis procedures, refer to "How to treat past trouble" (Refer to GROUP 00, How to treat past trouble [P.00-16](#)).

DIAGNOSIS**Required Special Tools:**

- MB991958: Scan Tool (MUT-III Sub Assembly)
 - MB991824: V.C.I.
 - MB991827: MUT-III USB Cable
 - MB991910: MUT-III Main Harness A
- MB991974: ABS Check Harness

STEP 1. Using scan tool MB991958, diagnose the CAN bus line.

⚠ CAUTION

To prevent damage to scan tool MB991958, always turn the ignition switch to the "LOCK" (OFF) position before connecting or disconnecting scan tool MB991958.

- (1) Connect scan tool MB991958 to the data link connector.
- (2) Turn the ignition switch to the "ON" position.
- (3) Diagnose the CAN bus line.
- (4) Turn the ignition switch to the "LOCK" (OFF) position.

Q: Is the CAN bus line found to be normal?

YES : Go to Step 3.

NO : Repair the CAN bus line (Refer to GROUP 54C, Diagnosis P.54C-14). Then go to Step 2.

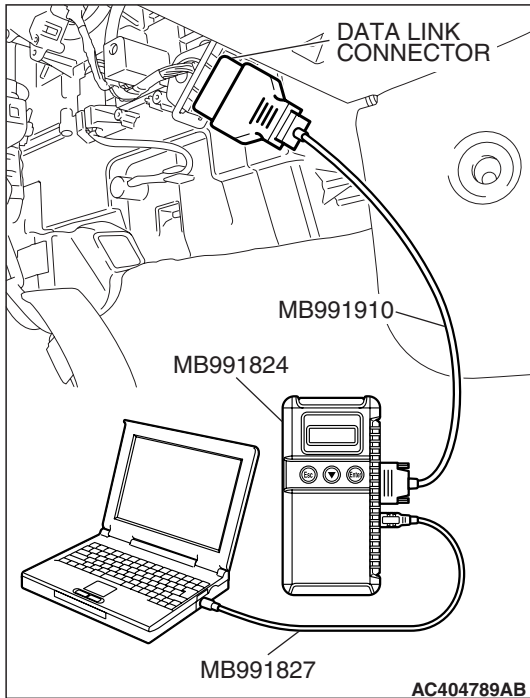

STEP 2. Recheck for diagnostic trouble code.

⚠ CAUTION

To prevent damage to scan tool MB991958, always turn the ignition switch to the "LOCK" (OFF) position before connecting or disconnecting scan tool MB991958.

- (1) Turn the ignition switch to the "ON" position.
- (2) Erase the DTC.
- (3) Turn the ignition switch to the "LOCK" (OFF) position.
- (4) Turn the ignition switch to the "ON" position.
- (5) Check if the DTC is set.
- (6) Turn the ignition switch to the "LOCK" (OFF) position.

Q: Is DTC C1211 set?

YES : Go to Step 3.

NO : The procedure is complete.

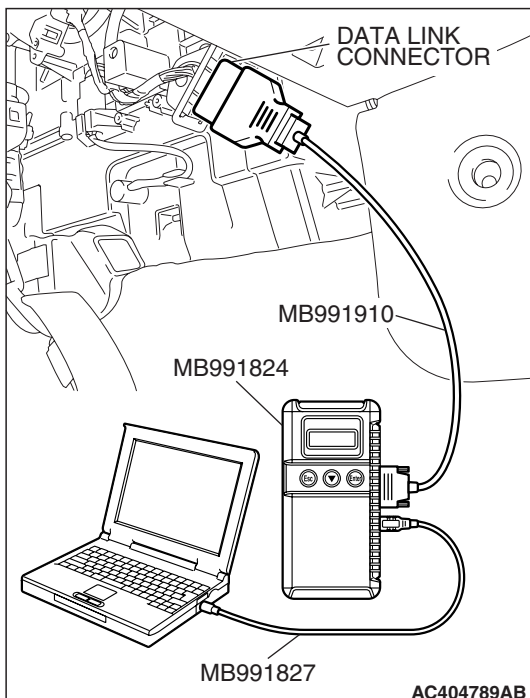

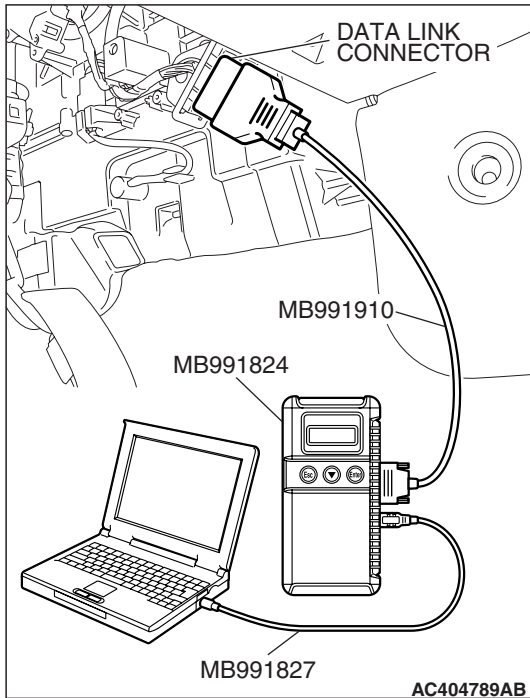

STEP 3. Using scan tool MB991958, read the diagnostic trouble code.

⚠ CAUTION

To prevent damage to scan tool MB991958, always turn the ignition switch to the "LOCK" (OFF) position before connecting or disconnecting scan tool MB991958.

Use scan tool MB991958 to check whether DTC code C1210 have been set simultaneously.

- (1) Connect scan tool MB991958 to the data link connector.
- (2) Turn the ignition switch to the "ON" position.
- (3) Check whether DTC C1210 have been set.
- (4) Turn the ignition switch to the "LOCK" (OFF) position.

Q: Is DTC C1210 set?

YES : Carry out diagnosis relevant to DTC C1210 (Refer to [P.35B-47](#)).

NO : Go to Step 4.

STEP 4. Check the installation condition of the wheel speed sensors.

For the wheel speed sensor, which the DTC code indicates, check whether the sensor or its mounting bolts are loosened.

- DTC C1211 is set: Rear right wheel speed sensor

Q: Is the wheel speed sensor installed correctly?

YES : Go to Step 5.

NO : Reinstall the wheel speed sensor correctly. Then go to Step 13.

STEP 5. Check the wheel speed sensor after it is removed from the vehicle.

Check the wheel speed sensor which the DTC code indicates (Refer to [P.35B-146](#)).

- DTC C1211 is set: Rear right wheel speed sensor

Q: Is the wheel speed sensor in good condition?

YES : Go to Step 6.

NO : Replace the wheel speed sensor (Refer to [P.35B-145](#)). Then go to Step 13.

STEP 6. Check the wheel bearing for looseness.

NOTE: If the wheel bearing is loose, the gap between the wheel speed sensor and rotor may become excessive. Check the wheel bearing, which DTC code indicates, for looseness.

- DTC C1211 is set: Check the rear right wheel bearing (Refer to GROUP 27, On-vehicle service –Wheel bearing end play check [P.27-4](#)).

Q: Is the wheel bearing end play within the standard value?

YES : Go to Step 7.

NO : Replace the rear hub assembly (Refer to GROUP 27, Rear axle hub assembly [P.27-4](#)).

STEP 7. Check the wheel speed rotor.

Check the wheel speed rotor, which DTC code indicates, for foreign material or deformation.

- DTC C1211 is set: Rear right wheel speed sensor

Q: Is the wheel speed rotor in good condition?

YES : Go to Step 8.

NO : If the wheel speed rotor is contaminated with foreign material, clean it. If the wheel speed rotor is deformed, replace it (Refer to GROUP 27, Rear axle hub assembly [P.27-6](#)).

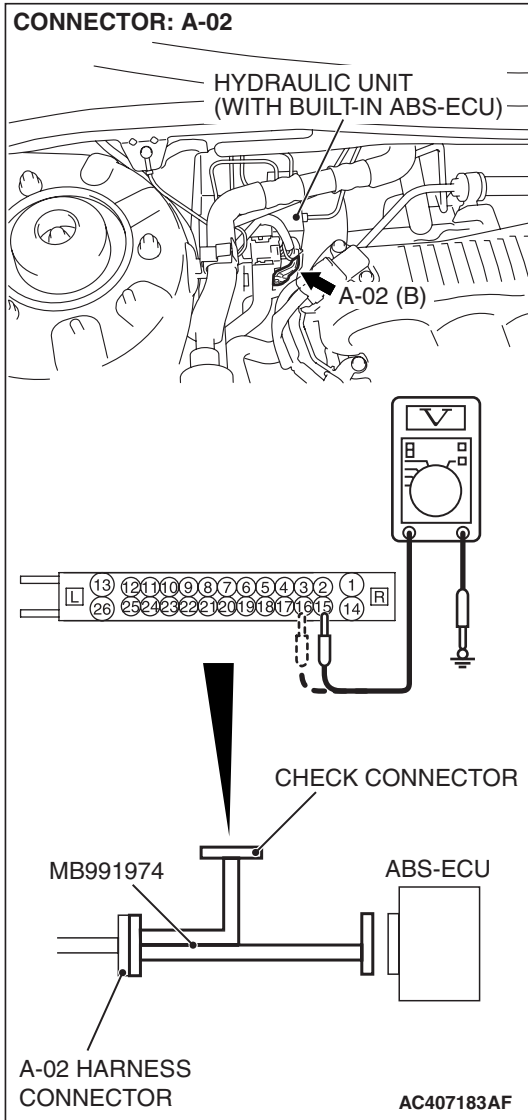

STEP 8. Measure the voltage at ABS-ECU connector A-02.

- (1) Disconnect the connector A-02, and connect special tool MB991974 to the wiring harness-side connector.

NOTE: Do not connect special tool MB991974 to the ABS-ECU.

- (2) Turn the ignition switch to the "ON" position.
- (3) Measure the voltage between terminal 15 and body ground, and between terminal 16 and body ground. It should be 1V or less.

Q: Does the voltage measure 1 V or less?

- YES :** Go to Step 9.
- NO :** Go to Step 11.

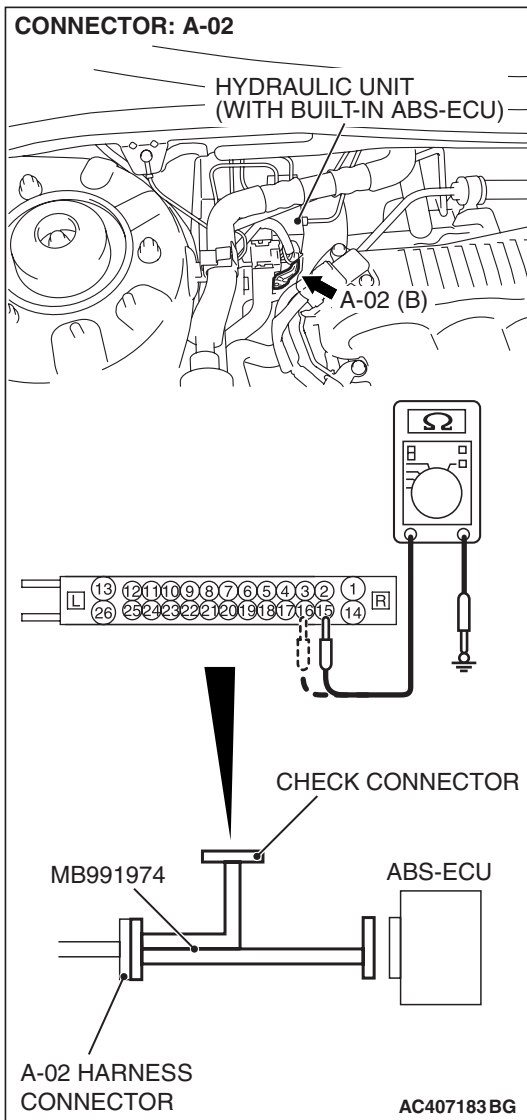

STEP 9. Measure the resistance at ABS-ECU connector A-02.

- (1) Disconnect the connector A-02, and connect special tool MB991974 to the wiring harness-side connector.

NOTE: Do not connect special tool MB991974 to the ABS-ECU.

- (2) Measure the resistance between terminal 15 and body ground, and between terminal 16 and body ground. There should be no continuity.

Q: Does continuity exist?

YES : Go to Step 11.

NO : Go to Step 10.

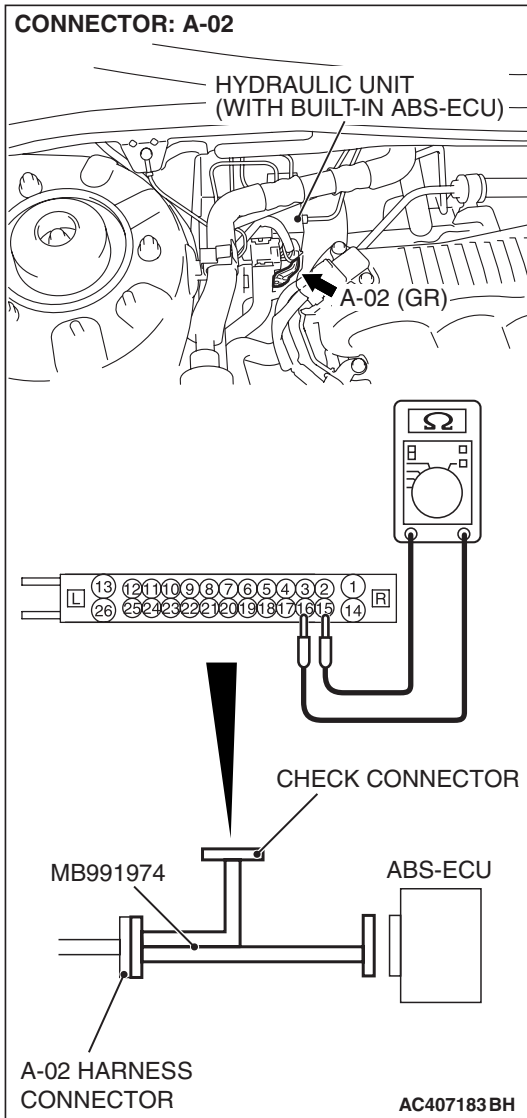

STEP 10. Measure the resistance at ABS-ECU connector A-02.

(1) Disconnect the connector A-02, and connect special tool MB991974 to the wiring harness-side connector.

NOTE: Do not connect special tool MB991974 to the ABS-ECU.

(2) Measure the resistance between terminals 15 and 16.

Standard Value: 1.24 –1.64 kΩ

Q: Is the resistance between terminals 15 and 16 within the standard value?

YES : Go to Step 12.

NO : Go to Step 11.

STEP 11. Check ABS-ECU connector A-02, intermediate connector C-26 and wheel speed sensor <Rear: RH> connector F-08 for loose, corroded or damaged terminals, or terminals pushed back in the connector.

Q: Are ABS-ECU connector A-02, intermediate connector C-26 and wheel speed sensor <Rear: RH> connector F-08 damaged?

YES : Repair or replace the damaged component(s). Refer to GROUP 00E, Harness Connector Inspection

P.00E-2. Then go to Step 13.

NO : Open or short circuit may be present in the rear right wheel speed sensor circuit. Repair the wiring harness between ABS-ECU connector A-02 (terminals 15 and 16) and rear right wheel speed sensor F-08 (terminals 2 and 1). Then go to Step 13.

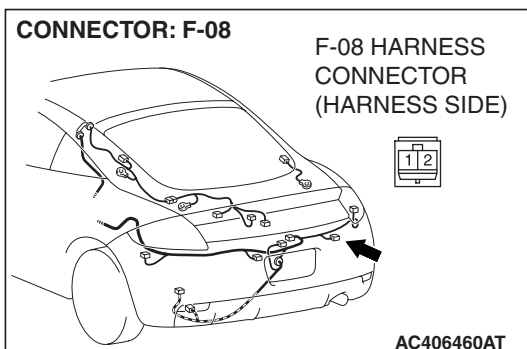
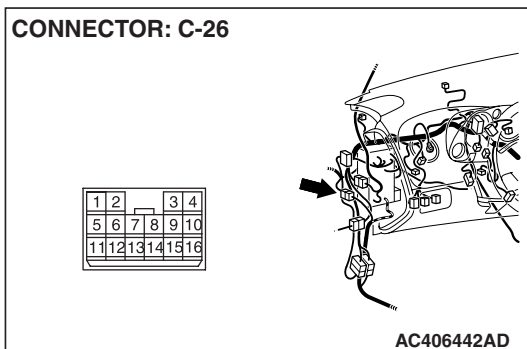
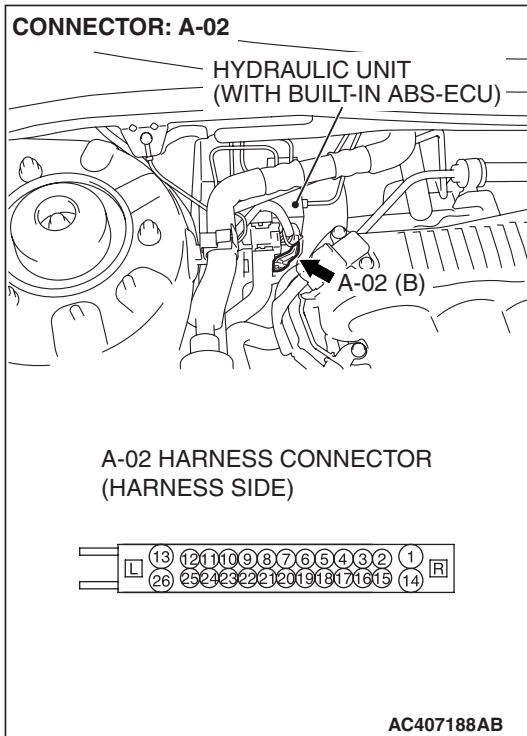

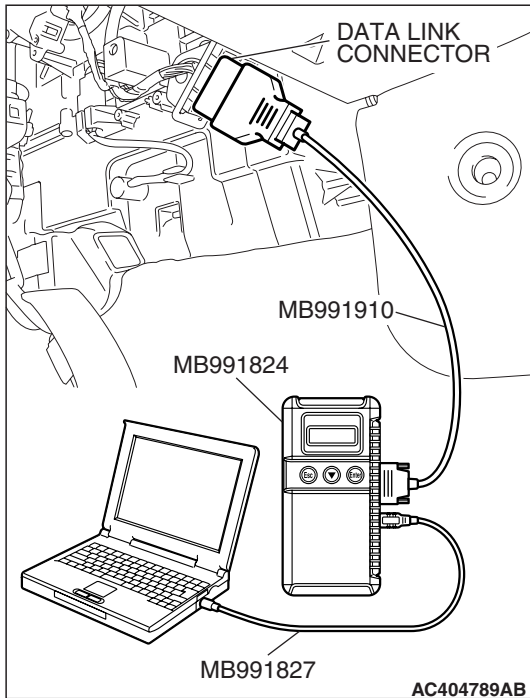
**STEP 12. Recheck for diagnostic trouble code.****⚠ CAUTION**

To prevent damage to scan tool MB991958, always turn the ignition switch to the "LOCK" (OFF) position before connecting or disconnecting scan tool MB991958.

Check again if the DTC is set.

- (1) Turn the ignition switch to the "ON" position.
- (2) Erase the DTC.
- (3) Turn the ignition switch to the "LOCK" (OFF) position.
- (4) Turn the ignition switch to the "ON" position.
- (5) Check if the DTC is set.
- (6) Turn the ignition switch to the "LOCK" (OFF) position.

Q: Is DTC C1211 set?

YES : Replace the hydraulic unit (integrated with ABS-ECU). Then go to Step 13.

NO : It can be assumed that this malfunction is intermittent. Refer to GROUP 00, How to Use Troubleshooting/Inspection Service Points –How to Cope with Intermittent Malfunction P.00-14.

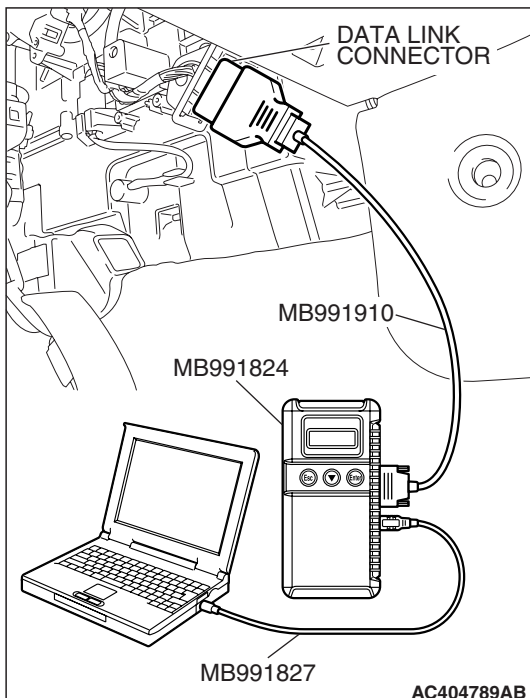
**STEP 13. Recheck for diagnostic trouble code.****⚠ CAUTION**

To prevent damage to scan tool MB991958, always turn the ignition switch to the "LOCK" (OFF) position before connecting or disconnecting scan tool MB991958.

Check again if the DTC is set.

- (1) Turn the ignition switch to the "ON" position.
- (2) Erase the DTC.
- (3) Turn the ignition switch to the "LOCK" (OFF) position.
- (4) Turn the ignition switch to the "ON" position.
- (5) Check if the DTC is set.
- (6) Turn the ignition switch to the "LOCK" (OFF) position.

Q: Is DTC C1211 set?

YES : Go to Step 1.

NO : The procedure is complete.

DTC C1215: Rear Left Wheel Speed Sensor (Open Circuit or Short Circuit)

Wheel Speed Sensor Circuit

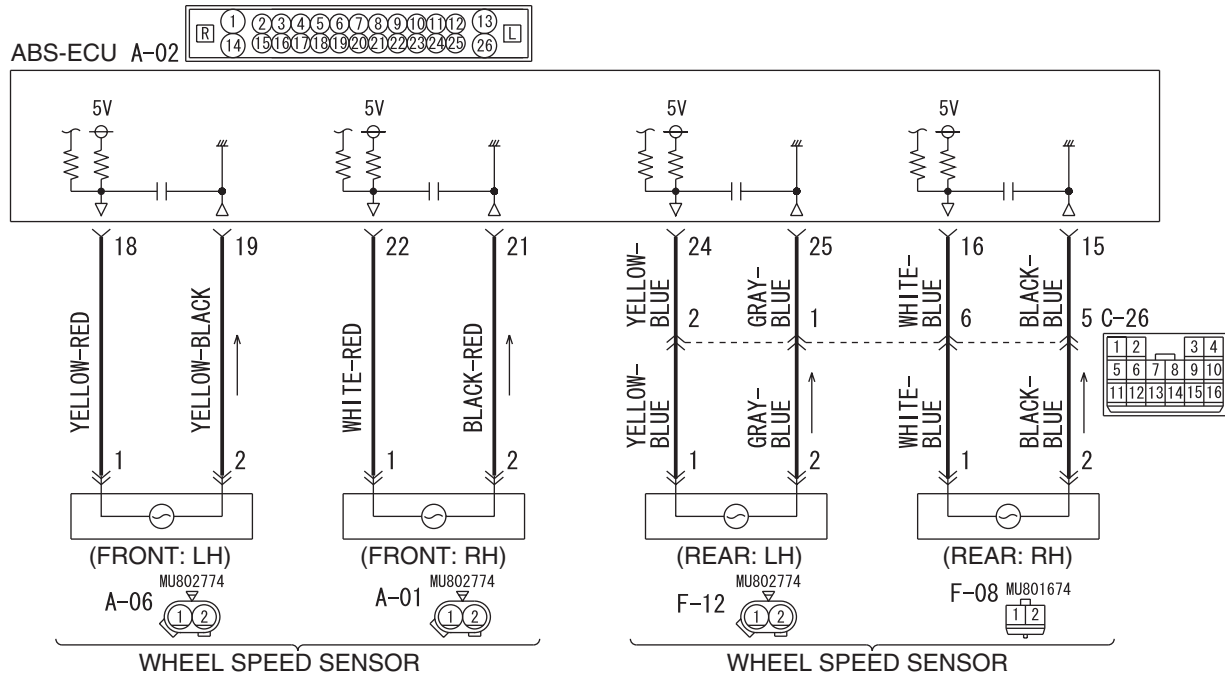

W6P35M000A

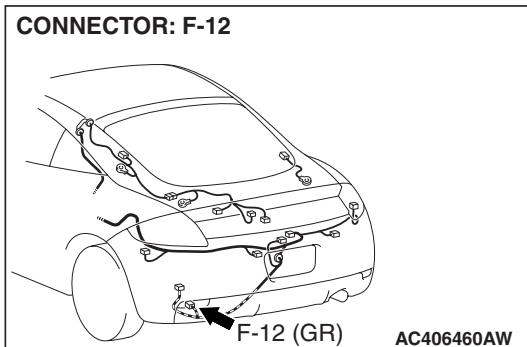
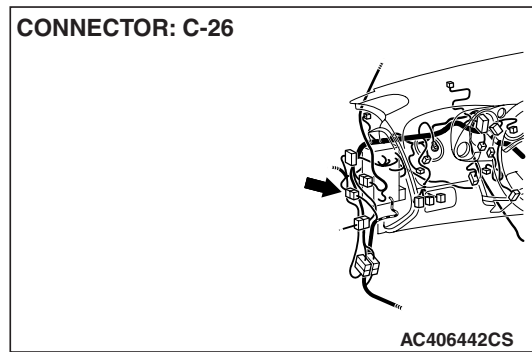
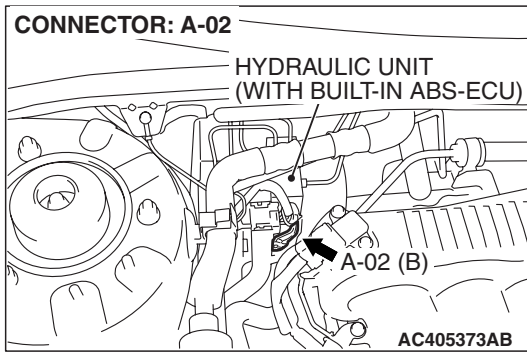

⚠ CAUTION

If there is any problem in the CAN bus lines, an incorrect diagnostic trouble code may be set. Prior to this diagnosis, diagnose the CAN bus lines. (Refer to GROUP 54C, Trouble code diagnosis P.54C-12).

CIRCUIT OPERATION

- A toothed wheel speed rotor generates a voltage pulse as it moves across the pickup field of each wheel speed sensor.
- The amount of voltage generated at each wheel is determined by the clearance between the wheel speed rotor teeth and the wheel speed sensor, and by the speed of rotation.
- Sends alternating current signals at frequencies which are proportional to the rotation speeds of each wheel to the ABS electronic control unit (ABS-ECU).
- The ABS hydraulic unit modulates the amount of braking force individually applied to each wheel cylinder.

ABS DTC SET CONDITIONS

The ABS-ECU monitors voltage fluctuation in each wheel speed sensor circuit. If the ECU detects a short or open circuit in the circuit, it will set a diagnostic trouble code.

TROUBLESHOOTING HINTS (THE MOST LIKELY CAUSES FOR THESE DTCS ARE TO SET ARE:)**Current trouble**

- Malfunction of the wheel speed sensor
- Damaged wiring harness or connector
- Malfunction of the hydraulic unit (integrated with ABS-ECU)

Past trouble

- Carry out diagnosis with particular emphasis on connector(s) or wiring harness in wheel speed sensor circuit. For diagnosis procedures, refer to "How to treat past trouble" (Refer to GROUP 00, How to treat past trouble P.00-16).

DIAGNOSIS**Required Special Tools:**

- MB991958: Scan Tool (MUT-III Sub Assembly)
 - MB991824: V.C.I.
 - MB991827: MUT-III USB Cable
 - MB991910: MUT-III Main Harness A
- MB991974: ABS Check Harness

STEP 1. Using scan tool MB991958, diagnose the CAN bus line.

⚠ CAUTION

To prevent damage to scan tool MB991958, always turn the ignition switch to the "LOCK" (OFF) position before connecting or disconnecting scan tool MB991958.

- (1) Connect scan tool MB991958 to the data link connector.
- (2) Turn the ignition switch to the "ON" position.
- (3) Diagnose the CAN bus line.
- (4) Turn the ignition switch to the "LOCK" (OFF) position.

Q: Is the CAN bus line found to be normal?

YES : Go to Step 3

NO : Repair the CAN bus line (Refer to GROUP 54C, Diagnosis P.54C-14). Then go to Step 2.

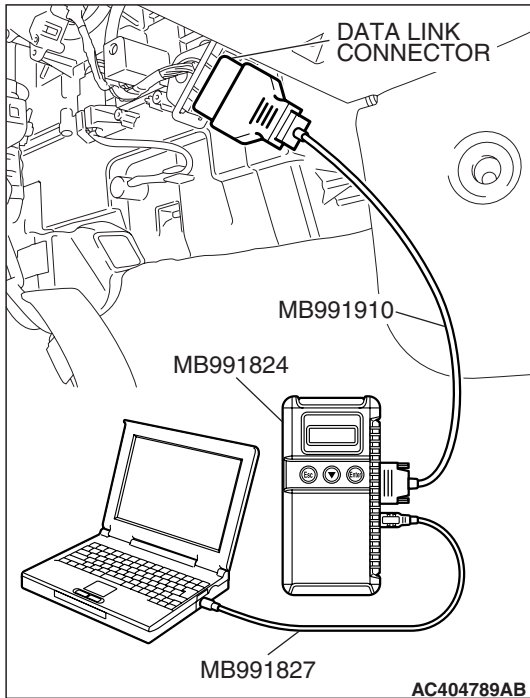

STEP 2. Recheck for diagnostic trouble code.

⚠ CAUTION

To prevent damage to scan tool MB991958, always turn the ignition switch to the "LOCK" (OFF) position before connecting or disconnecting scan tool MB991958.

- (1) Turn the ignition switch to the "ON" position.
- (2) Erase the DTC.
- (3) Turn the ignition switch to the "LOCK" (OFF) position.
- (4) Turn the ignition switch to the "ON" position.
- (5) Check if the DTC is set.
- (6) Turn the ignition switch to the "LOCK" (OFF) position.

Q: Is DTC C1215 set?

YES : Go to Step 3

NO : The procedure is complete.

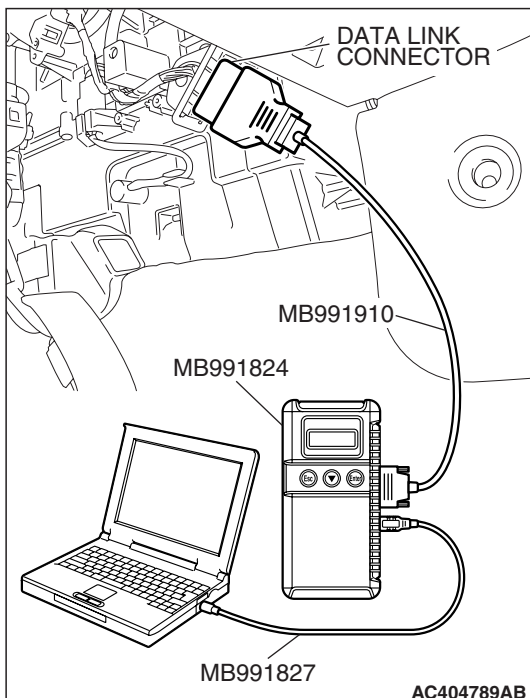

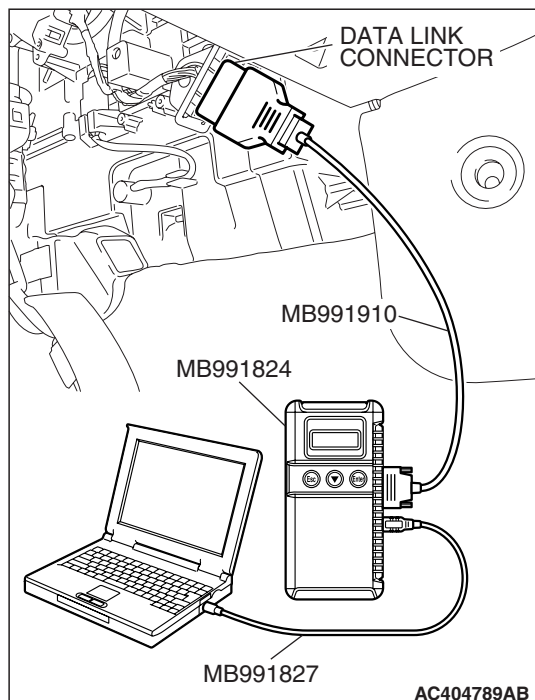
**STEP 3. Using scan tool MB991958, check data list.****⚠ CAUTION**

To prevent damage to scan tool MB991958, always turn the ignition switch to the "LOCK" (OFF) position before connecting or disconnecting scan tool MB991958.

- (1) Connect scan tool MB991958 to the data link connector.
- (2) Start the engine.
- (3) Set scan tool MB991958 to the data reading mode, and check the data list items by driving the vehicle (Refer to [P.35B-131](#)).
 - Item 04: Rear left wheel speed sensor
- (4) Turn the ignition switch to the "LOCK" (OFF) position.

Q: Does the speedometer indication match the scan tool indication?

YES : It can be assumed that this malfunction is intermittent.

Refer to GROUP 00, How to Use Troubleshooting/Inspection Service Points –How to Cope with Intermittent Malfunction [P.00-14](#).

NO : Go to Step 4.

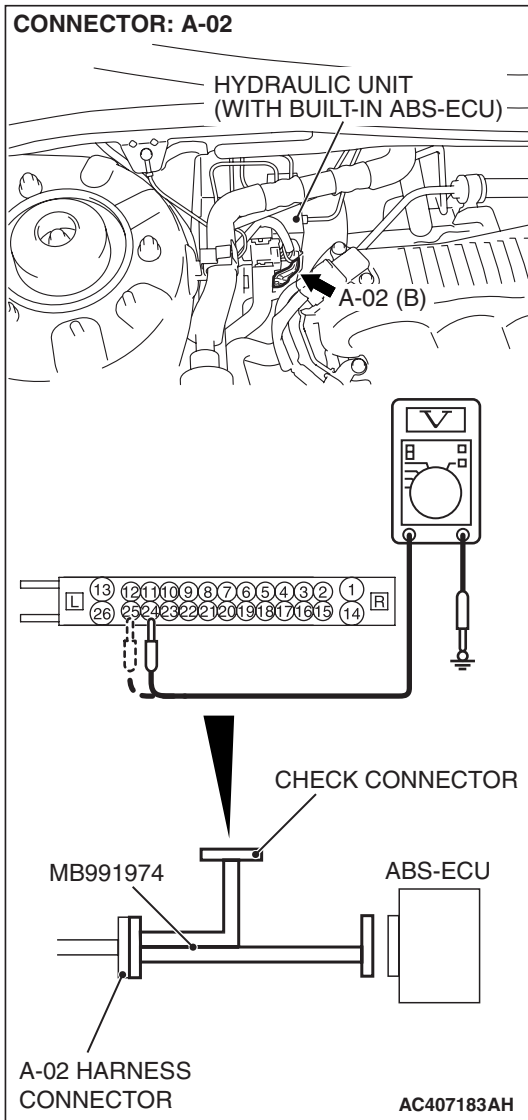

STEP 4. Measure the voltage at ABS-ECU connector A-02.

- (1) Disconnect the connector A-02, and connect special tool MB991974 to the wiring harness-side connector.

NOTE: Do not connect special tool MB991974 to the ABS-ECU.

- (2) Turn the ignition switch to the "ON" position.
- (3) Measure the voltage between terminal 24 and body ground, and between terminal 25 and body ground. It should be 1V or less.

Q: Does the voltage measure 1 V or less?

YES : Go to Step 5.

NO : Go to Step 7.

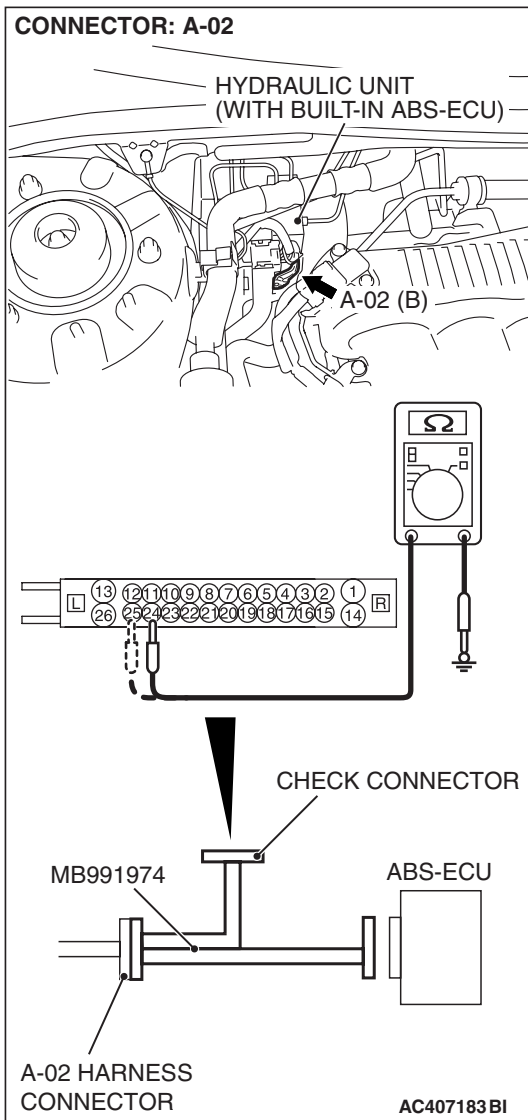

STEP 5. Measure the resistance at ABS-ECU connector A-02.

(1) Disconnect the connector A-02, and connect special tool MB991974 to the wiring harness-side connector.

NOTE: Do not connect special tool MB991974 to the ABS-ECU.

(2) Measure the resistance between terminal 24 and body ground, and between terminal 25 and body ground. There should be no continuity.

Q: Does continuity exist?

YES : Go to Step 7.

NO : Go to Step 6.

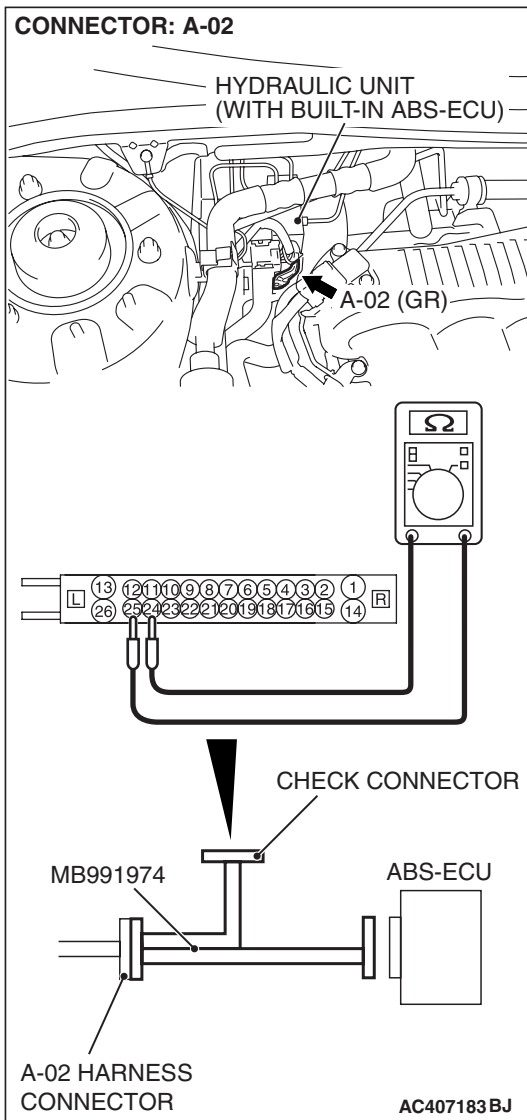

STEP 6. Measure the resistance at the ABS-ECU connector A-02.

- (1) Disconnect the connector A-02, and connect special tool MB991974 to the wiring harness-side connector.

NOTE: Do not connect special tool MB991974 to the ABS-ECU.

- (2) Measure the resistance between the ABS-ECU connector terminals 24 and 25.

Standard Value: 1.24 – 1.64 k Ω

Q: Is the resistance between terminals 24 and 25 within the standard value?

YES : Go to Step 10.

NO : Go to Step 7.

STEP 7. Check ABS-ECU connector A-02, intermediate connector C-26 and wheel speed sensor <rear: LH> connector F-12 for loose, corroded or damaged terminals, or terminals pushed back in the connector.

Q: Are ABS-ECU connector A-02, intermediate connector C-26 and wheel speed sensor <rear: LH> connector F-12 damaged?

YES : Repair or replace the damaged component(s). Refer to GROUP 00E, Harness Connector Inspection

[P.00E-2](#). Then go to Step 11.

NO : Go to Step 8.

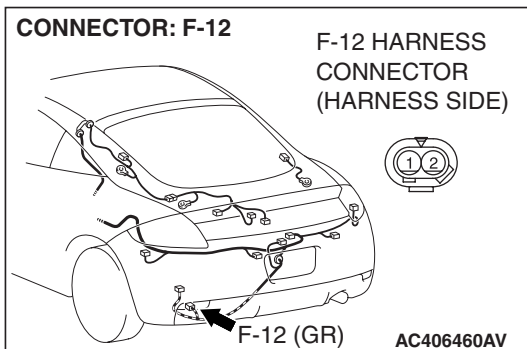
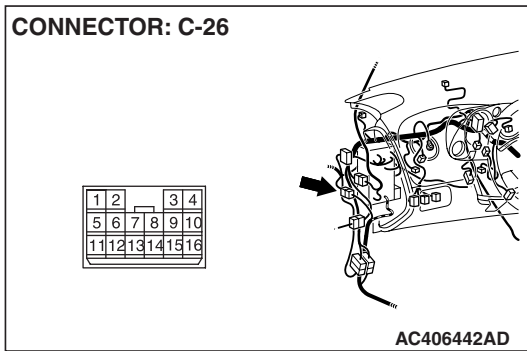
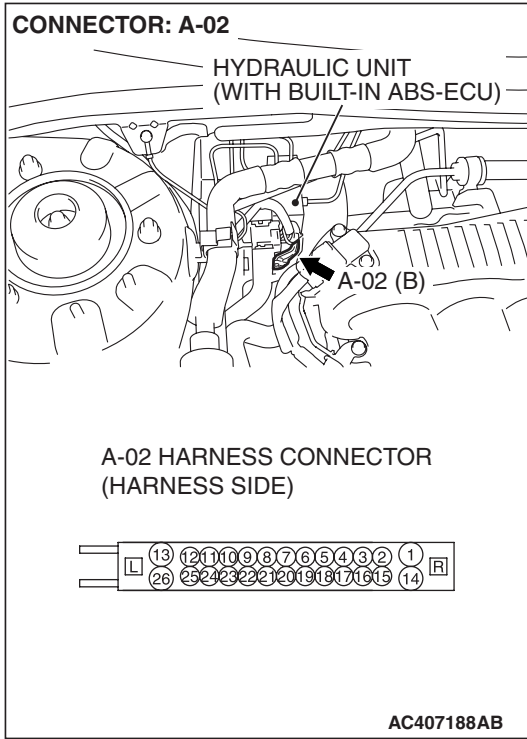

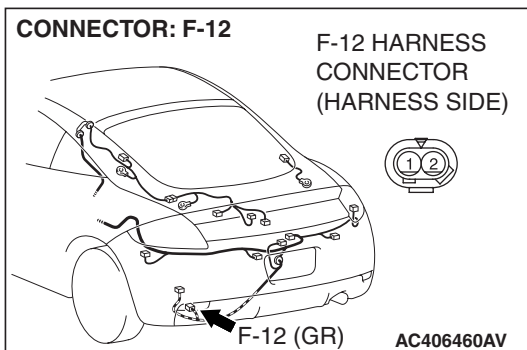
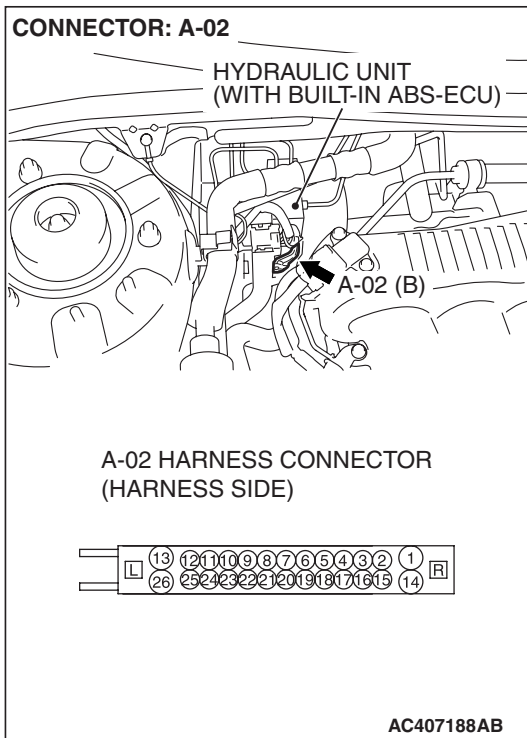

STEP 8. Check the harness wires between ABS-ECU connector A-02 (terminal 24, 25) and wheel speed sensor <rear: LH> connector F-12 (terminal 1, 2).

Q: Is the harness wire between ABS-ECU connector A-02 (terminal 24, 25) and wheel speed sensor <rear: LH> connector F-12 (terminal 1, 2) damaged?

YES : Repair the wiring harness. Then go to Step 11.

NO : Go to Step 9.

STEP 9. Inspect the wheel speed sensor.

Check the wheel speed sensor relevant to the DTC code. For the applicable inspection procedure, refer to [P.35B-146](#).

- When DTC code C1216 is set: Rear left wheel speed sensor

Q: Is the wheel speed sensor damaged?

YES : Replace the wheel speed sensor. Then go to Step 11.

NO : It can be assumed that this malfunction is intermittent. Refer to GROUP 00, How to Use Troubleshooting/Inspection Service Points –How to Cope with Intermittent Malfunction [P.00-14](#).

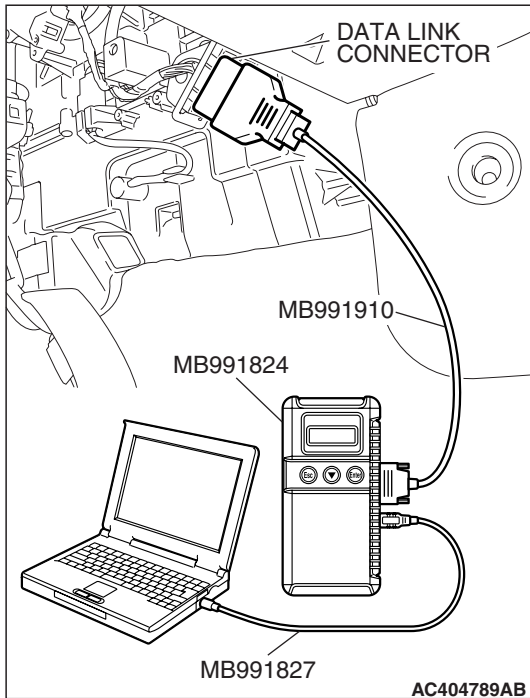
**STEP 10. Recheck for diagnostic trouble code.****⚠ CAUTION**

To prevent damage to scan tool MB991958, always turn the ignition switch to the "LOCK" (OFF) position before connecting or disconnecting scan tool MB991958.

Check again if the DTC is set.

- (1) Turn the ignition switch to the "ON" position.
- (2) Erase the DTC.
- (3) Turn the ignition switch to the "LOCK" (OFF) position.
- (4) Turn the ignition switch to the "ON" position.
- (5) Check if the DTC is reset.
- (6) Turn the ignition switch to the "LOCK" (OFF) position.

Q: Is DTC C1215 set?

YES : Replace the hydraulic unit (integrated with ABS-ECU). Then go to Step 11.

NO : It can be assumed that this malfunction is intermittent. Refer to GROUP 00, How to Use Troubleshooting/Inspection Service Points –How to Cope with Intermittent Malfunction [P.00-14](#).

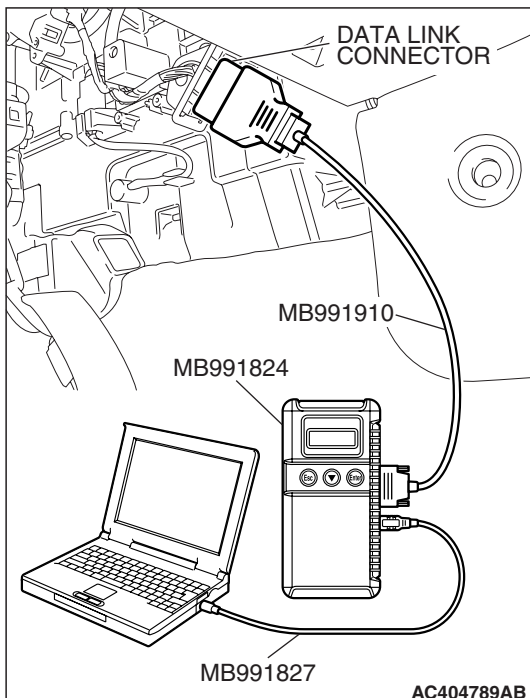
**STEP 11. Recheck for diagnostic trouble code.****⚠ CAUTION**

To prevent damage to scan tool MB991958, always turn the ignition switch to the "LOCK" (OFF) position before connecting or disconnecting scan tool MB991958.

- (1) Turn the ignition switch to the "ON" position.
- (2) Erase the DTC.
- (3) Turn the ignition switch to the "LOCK" (OFF) position.
- (4) Turn the ignition switch to the "ON" position.
- (5) Check if the DTC is set.
- (6) Turn the ignition switch to the "LOCK" (OFF) position.

Q: Is DTC C1215 set?

YES : Repeat the troubleshooting from Step 1.

NO : The procedure is complete.

DTC C1216: Rear Left Wheel Speed Sensor (Abnormal Output Signal)

Wheel Speed Sensor Circuit

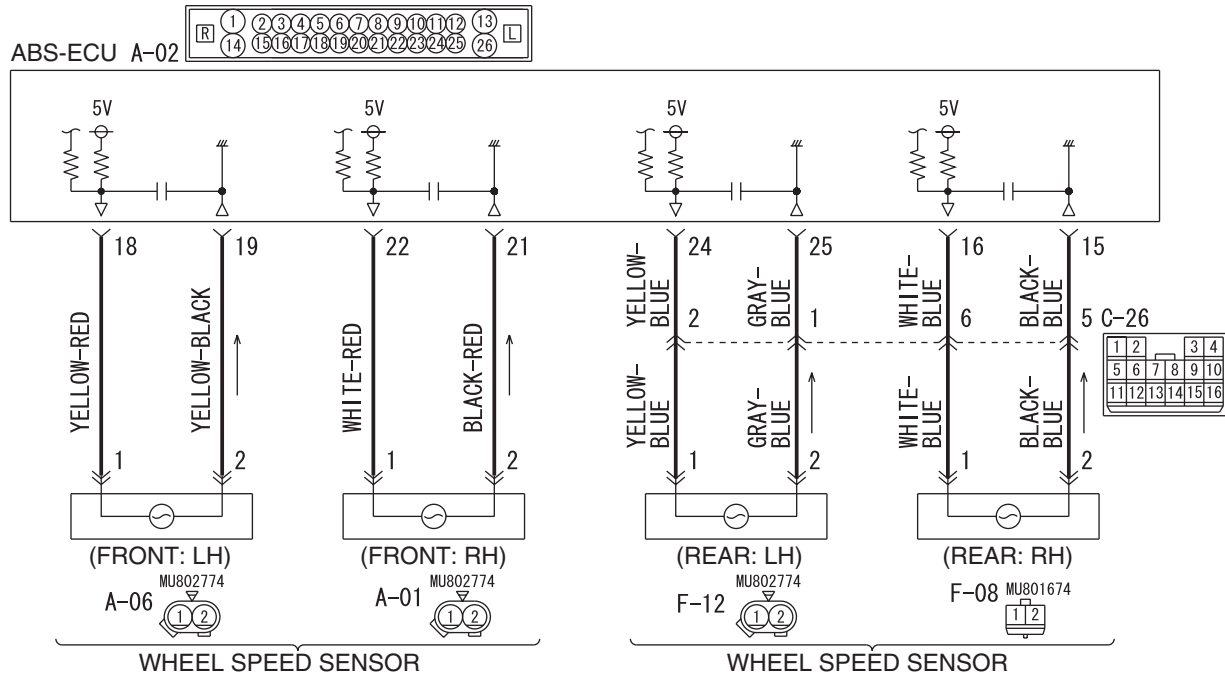

W6P35M000A

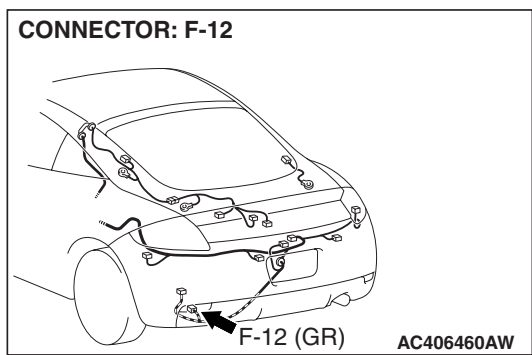
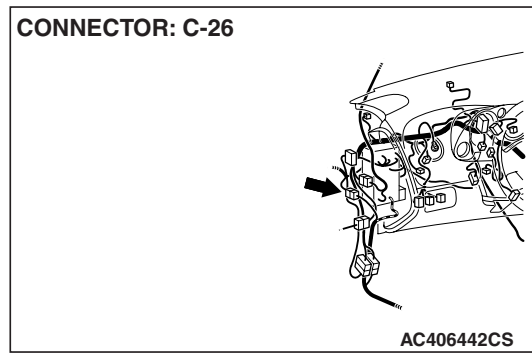
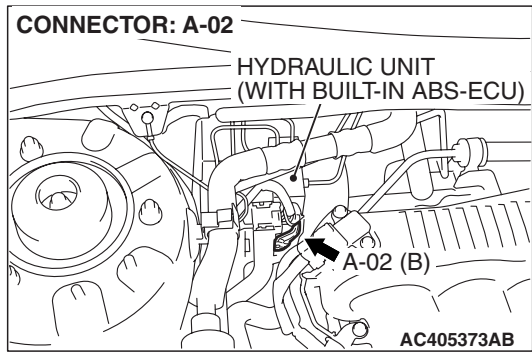

⚠ CAUTION

If there is any problem in the CAN bus lines, an incorrect diagnostic trouble code may be set. Prior to this diagnosis, diagnose the CAN bus lines. (Refer to GROUP 54C, Trouble code diagnosis P.54C-12).

CIRCUIT OPERATION

- A toothed wheel speed rotor generates a voltage pulse as it moves across the pickup field of each wheel speed sensor.
- The amount of voltage generated at each wheel is determined by the clearance between the wheel speed rotor teeth and the wheel speed sensor, and by the speed of rotation.
- Sends alternating current signals at frequencies which are proportional to the rotation speeds of each wheel to the ABS electronic control unit (ABS-ECU).
- The ABS hydraulic unit modulates the amount of braking force individually applied to each wheel cylinder.

ABS DTC SET CONDITIONS

The ABS-ECU monitors the signals from each wheel speed sensor while the vehicle is being driven. If any fault below is found in these sensor signals, the ECU will set the relevant diagnostic trouble code.

- Missing sensor signal
- Sensor signal, which will not be created under normal operation
- Significant difference among the wheel speed sensor signals

TROUBLESHOOTING HINTS (THE MOST LIKELY CAUSES FOR THESE DTCS ARE TO SET ARE:)**Current trouble**

- Malfunction of the wheel speed sensor or wheel speed rotor
- Damaged wiring harness or connector
- Malfunction of the hydraulic unit (integrated with ABS-ECU)

Past trouble

- Carry out diagnosis with particular emphasis on connector(s) or wiring harness in wheel speed sensor circuit. For diagnosis procedures, refer to "How to treat past trouble" (Refer to GROUP 00, How to treat past trouble P.00-16).

DIAGNOSIS**Required Special Tools:**

- MB991958: Scan Tool (MUT-III Sub Assembly)
 - MB991824: V.C.I.
 - MB991827: MUT-III USB Cable
 - MB991910: MUT-III Main Harness A
- MB991974: ABS Check Harness

STEP 1. Using scan tool MB991958, diagnose the CAN bus line.

⚠ CAUTION

To prevent damage to scan tool MB991958, always turn the ignition switch to the "LOCK" (OFF) position before connecting or disconnecting scan tool MB991958.

- (1) Connect scan tool MB991958 to the data link connector.
- (2) Turn the ignition switch to the "ON" position.
- (3) Diagnose the CAN bus line.
- (4) Turn the ignition switch to the "LOCK" (OFF) position.

Q: Is the CAN bus line found to be normal?

YES : Go to Step 3

NO : Repair the CAN bus line (Refer to GROUP 54C, Diagnosis P.54C-14). Then go to Step 2.

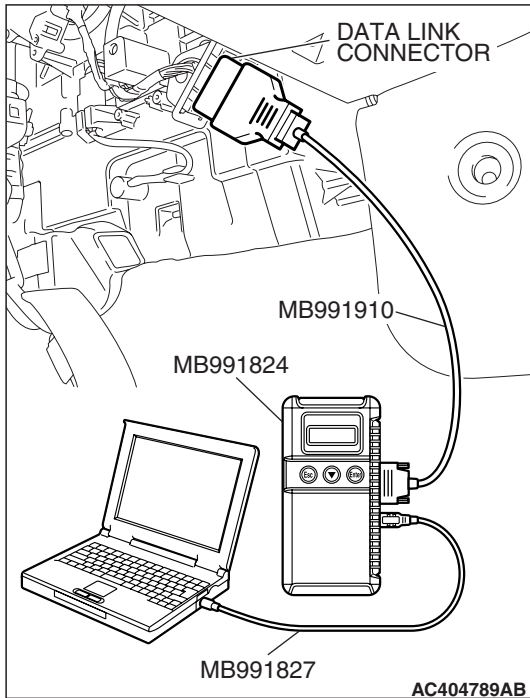

STEP 2. Recheck for diagnostic trouble code.

⚠ CAUTION

To prevent damage to scan tool MB991958, always turn the ignition switch to the "LOCK" (OFF) position before connecting or disconnecting scan tool MB991958.

- (1) Turn the ignition switch to the "ON" position.
- (2) Erase the DTC.
- (3) Turn the ignition switch to the "LOCK" (OFF) position.
- (4) Turn the ignition switch to the "ON" position.
- (5) Check if the DTC is set.
- (6) Turn the ignition switch to the "LOCK" (OFF) position.

Q: Is DTC C1216 set?

YES : Go to Step 3

NO : The procedure is complete.

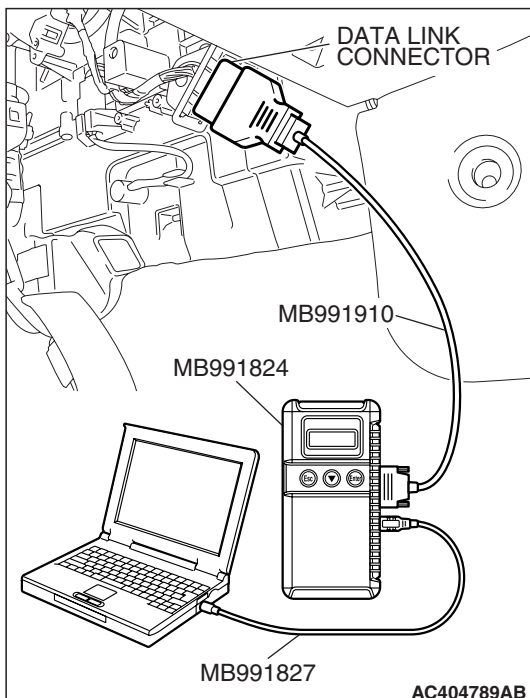

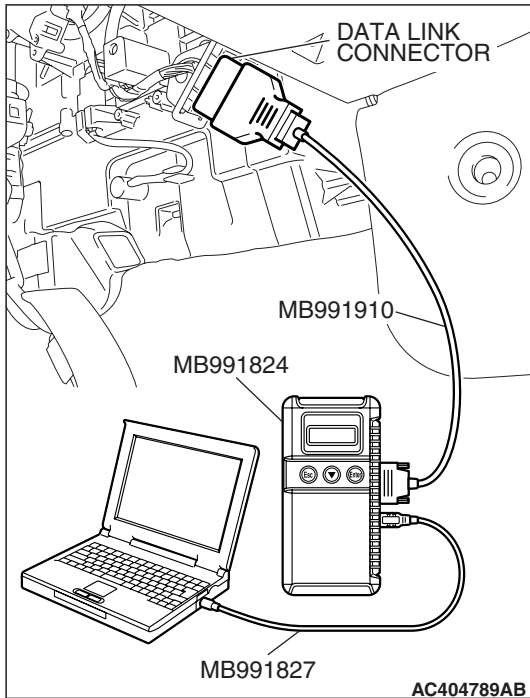

STEP 3. Using scan tool MB991958, read the diagnostic trouble code.

⚠ CAUTION

To prevent damage to scan tool MB991958, always turn the ignition switch to the "LOCK" (OFF) position before connecting or disconnecting scan tool MB991958.

Use scan tool MB991958 to check whether DTC code C1215 have been set simultaneously.

- (1) Connect scan tool MB991958 to the data link connector.
- (2) Turn the ignition switch to the "ON" position.
- (3) Check whether DTC C1215 have been set.
- (4) Turn the ignition switch to the "LOCK" (OFF) position.

Q: Is DTC C1215 set?

YES : Carry out diagnosis relevant to DTC C1215 (Refer to [P.35B-67](#)).

NO : Go to Step 4.

STEP 4. Check the installation condition of the wheel speed sensors.

For the wheel speed sensor, which the DTC code indicates, check whether the sensor or its mounting bolts are loosened.

- DTC C1216 is set: Rear left wheel speed sensor

Q: Is the wheel speed sensor installed correctly?

YES : Go to Step 5.

NO : Reinstall the wheel speed sensor correctly. Then go to Step 13.

STEP 5. Check the wheel speed sensor after it is removed from the vehicle.

Check the wheel speed sensor which the DTC code indicates (Refer to [P.35B-146](#)).

- DTC C1216 is set: Rear left wheel speed sensor

Q: Is the wheel speed sensor in good condition?

YES : Go to Step 6.

NO : Replace the wheel speed sensor (Refer to [P.35B-145](#)). Then go to Step 13.

STEP 6. Check the wheel bearing for looseness.

NOTE: If the wheel bearing is loose, the gap between the wheel speed sensor and rotor may become excessive. Check the wheel bearing, which DTC code indicates, for looseness.

- DTC C1216 is set: Check the rear left wheel bearing (Refer to GROUP 27, On-vehicle service –Wheel bearing end play check [P.27-4](#)).

Q: Is the wheel bearing end play within the standard value?

YES : Go to Step 7.

NO : Replace the rear hub assembly (Refer to GROUP 27, Rear axle hub assembly [P.27-4](#)).

STEP 7. Check the wheel speed rotor.

Check the wheel speed rotor, which DTC code indicates, for foreign material or deformation.

- DTC C1216 is set: Rear left wheel speed sensor

Q: Is the wheel speed rotor in good condition?

YES : Go to Step 8.

NO : If the wheel speed rotor is contaminated with foreign material, clean it. If the wheel speed rotor is deformed, replace it (Refer to GROUP 27, Rear axle hub assembly [P.27-6](#)).

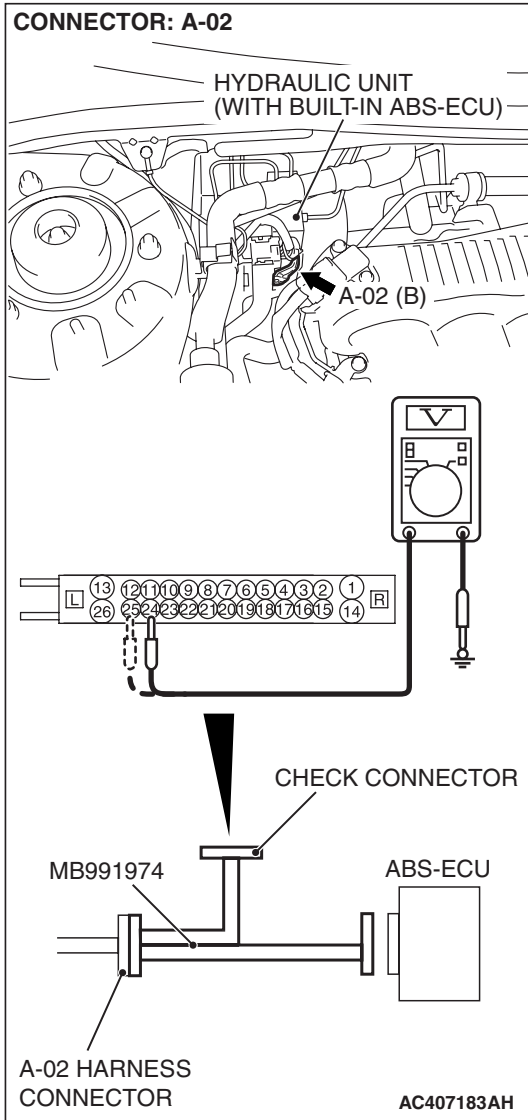

STEP 8. Measure the voltage at ABS-ECU connector A-02.

- (1) Disconnect the connector A-02, and connect special tool MB991974 to the wiring harness-side connector.

NOTE: Do not connect special tool MB991974 to the ABS-ECU.

- (2) Turn the ignition switch to the "ON" position.
- (3) Measure the voltage between terminal 24 and body ground, and between terminal 25 and body ground. It should be 1V or less.

Q: Does the voltage measure 1 V or less?

YES : Go to Step 9.

NO : Go to Step 11.

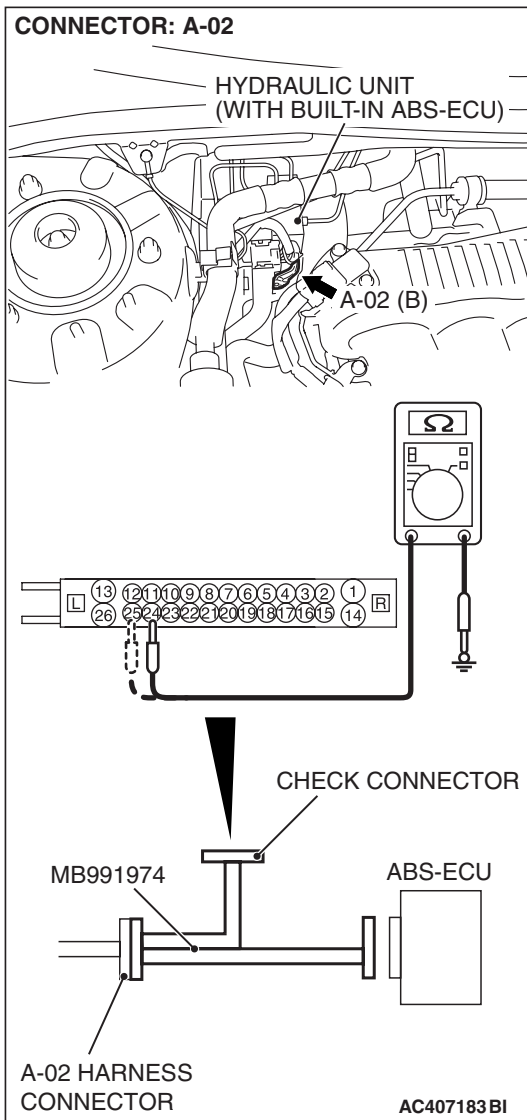

STEP 9. Measure the resistance at ABS-ECU connector A-02.

(1) Disconnect the connector A-02, and connect special tool MB991974 to the wiring harness-side connector.

NOTE: Do not connect special tool MB991974 to the ABS-ECU.

(2) Measure the resistance between terminal 24 and body ground, and between terminal 25 and body ground. There should be no continuity.

Q: Does continuity exist?

YES : Go to Step 11.

NO : Go to Step 10.

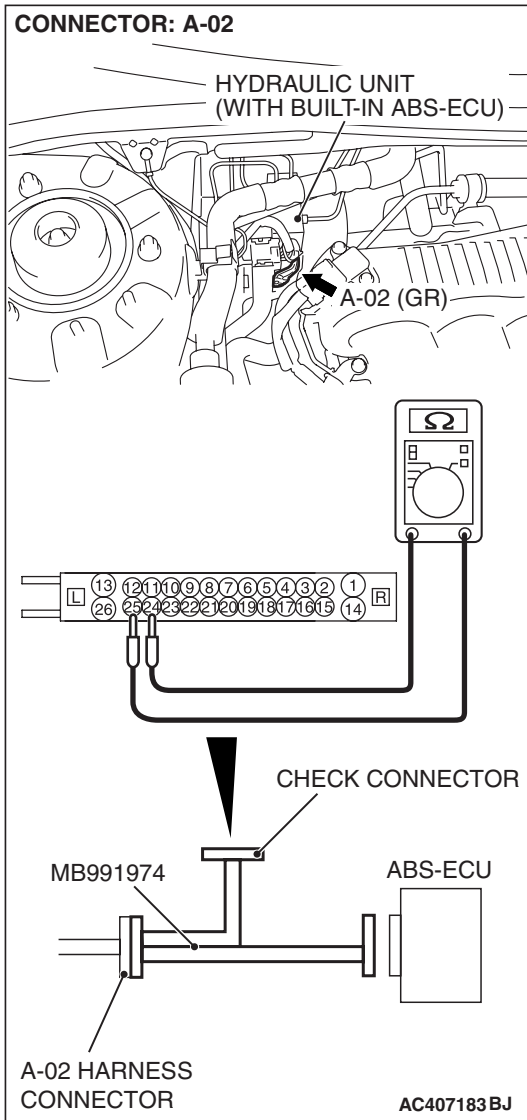

STEP 10. Measure the resistance at ABS-ECU connector A-02.

(1) Disconnect the connector A-02, and connect special tool MB991974 to the wiring harness-side connector.

NOTE: Do not connect special tool MB991974 to the ABS-ECU.

(2) Measure the resistance between signal terminals 24 and 25.

Standard Value: 1.24 –1.64 kΩ

Q: Is the resistance between terminals 24 and 25 within the standard value?

YES : Go to Step 12.

NO : Go to Step 11.

STEP 11. Check ABS-ECU connector A-02, intermediate connector C-26 and wheel speed sensor <Rear: LH> connector F-12 for loose, corroded or damaged terminals, or terminals pushed back in the connector.

Q: Are ABS-ECU connector A-02, intermediate connector C-26 and wheel speed sensor <Rear: LH> connector F-12 damaged?

YES : Repair or replace the damaged component(s). Refer to GROUP 00E, Harness Connector Inspection

P.00E-2. Then go to Step 13.

NO : Open or short circuit may be present in the rear left wheel speed sensor circuit. Repair the wiring harness between ABS-ECU connector A-02 (terminals 24 and 25) and rear left wheel speed sensor F-12 (terminals 1 and 2). Then go to Step 13.

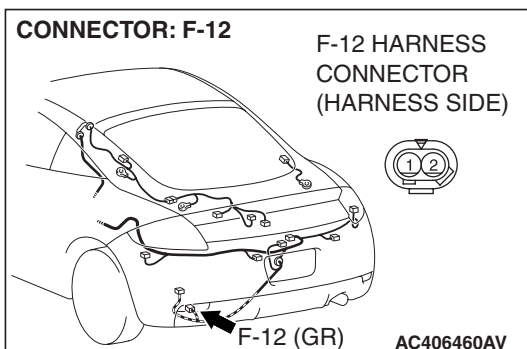
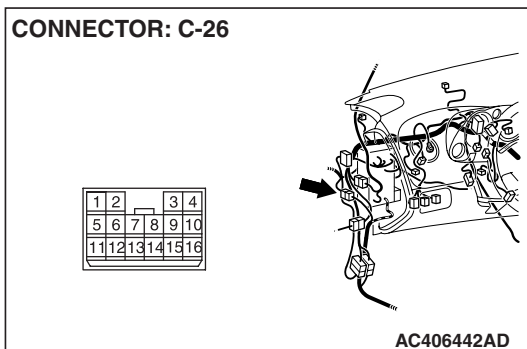
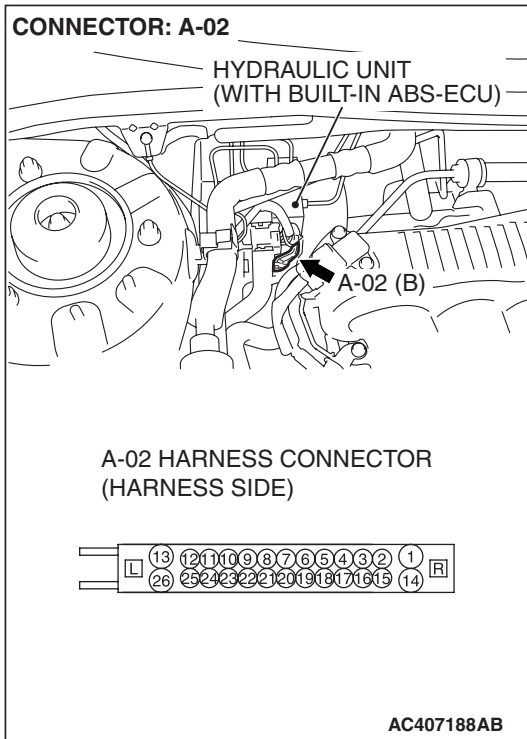

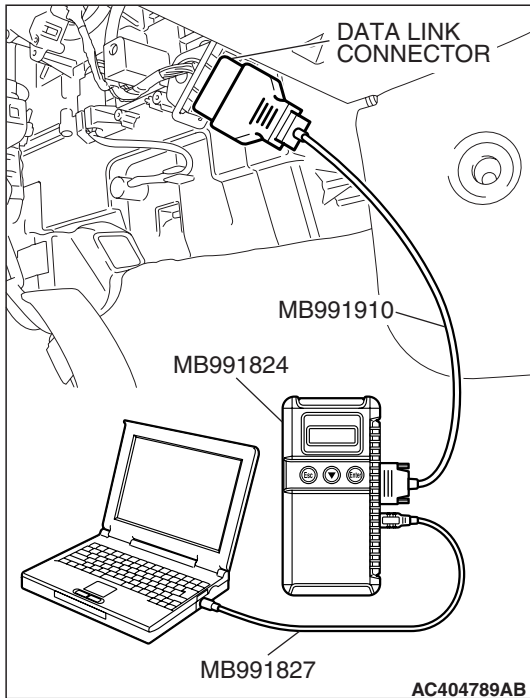
**STEP 12. Recheck for diagnostic trouble code.****⚠ CAUTION**

To prevent damage to scan tool MB991958, always turn the ignition switch to the "LOCK" (OFF) position before connecting or disconnecting scan tool MB991958.

Check again if the DTC is set.

- (1) Turn the ignition switch to the "ON" position.
- (2) Erase the DTC.
- (3) Turn the ignition switch to the "LOCK" (OFF) position.
- (4) Turn the ignition switch to the "ON" position.
- (5) Check if the DTC is set.
- (6) Turn the ignition switch to the "LOCK" (OFF) position.

Q: Is DTC C1216 set?

YES : Replace the hydraulic unit (integrated with ABS-ECU). Then go to Step 13.

NO : It can be assumed that this malfunction is intermittent. Refer to GROUP 00, How to Use Troubleshooting/Inspection Service Points –How to Cope with Intermittent Malfunction [P.00-14](#).

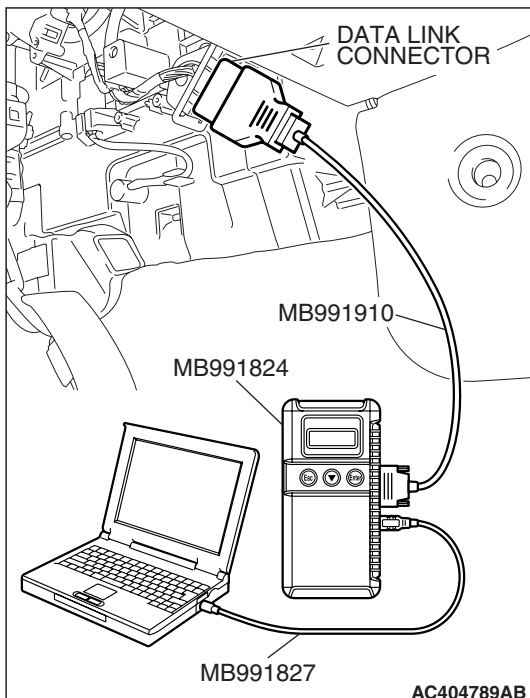
**STEP 13. Recheck for diagnostic trouble code.****⚠ CAUTION**

To prevent damage to scan tool MB991958, always turn the ignition switch to the "LOCK" (OFF) position before connecting or disconnecting scan tool MB991958.

Check again if the DTC is set.

- (1) Turn the ignition switch to the "ON" position.
- (2) Erase the DTC.
- (3) Turn the ignition switch to the "LOCK" (OFF) position.
- (4) Turn the ignition switch to the "ON" position.
- (5) Check if the DTC is set.
- (6) Turn the ignition switch to the "LOCK" (OFF) position.

Q: Is DTC C1216 set?

YES : Go to Step 1.

NO : The procedure is complete.

- DTC C1226: ABS Front Right Solenoid Valve (Pressure Holding System)**
- DTC C1231: ABS Front Right Solenoid Valve (Depressurizing System)**
- DTC C1236: ABS Front Left Solenoid Valve (Pressure Holding System)**
- DTC C1241: ABS Front Left Solenoid Valve (Depressurizing System)**
- DTC C1246: ABS Rear Right Solenoid Valve (Pressure Holding System)**
- DTC C1251: ABS Rear Right Solenoid Valve (Depressurizing System)**
- DTC C1256: ABS Rear Left Solenoid Valve (Pressure Holding System)**
- DTC C1261: ABS Rear Left Solenoid Valve (Depressurizing System)**

Solenoid Valve and Motor Power Supply Circuit

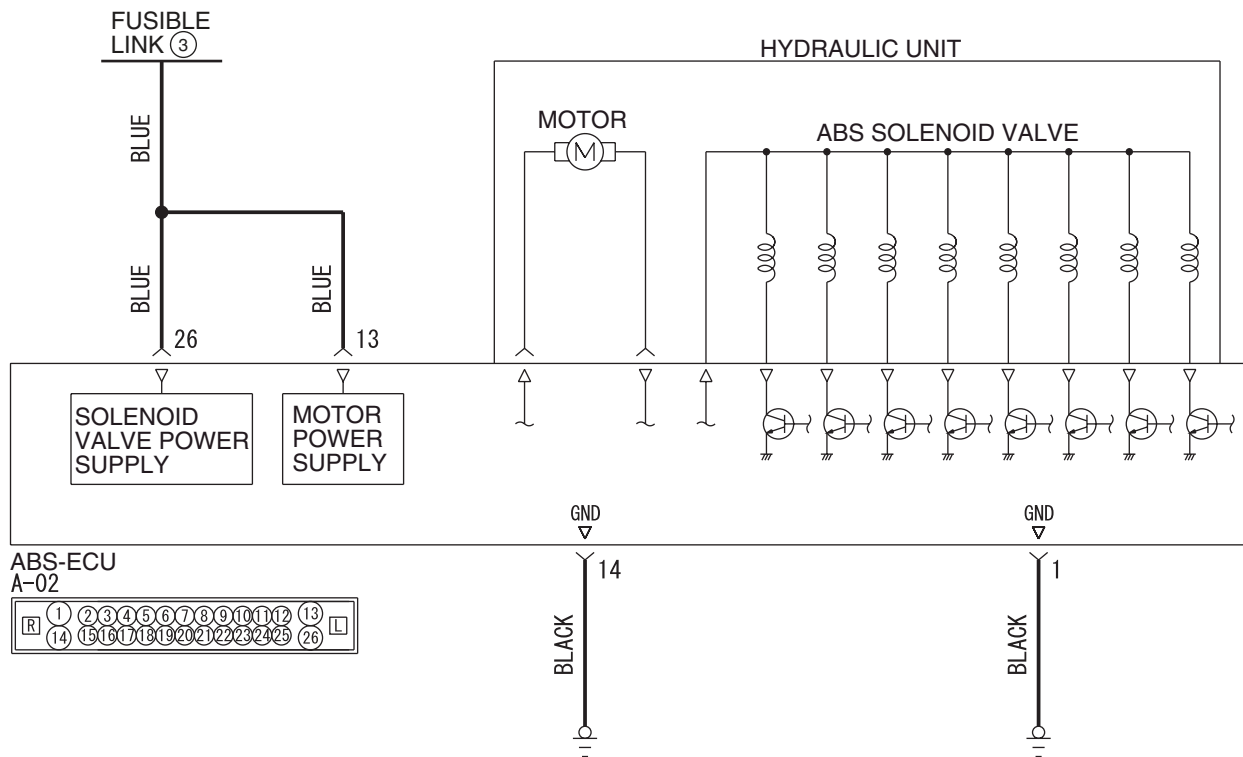

W6P35M002A

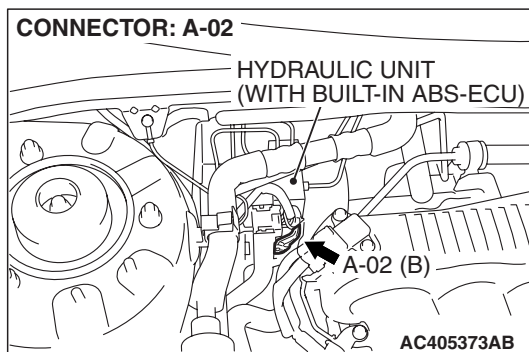

⚠ CAUTION

If there is any problem in the CAN bus lines, an incorrect diagnostic trouble code may be set. Prior to this diagnosis, diagnose the CAN bus lines. (Refer to GROUP 54C, Trouble code diagnosis P.54C-12).

CIRCUIT OPERATION

- The ABS-ECU contains the power supply circuit (terminal 1) for the solenoid valve. The solenoid valve is energized by the valve relay, which is integrated in the ABS-ECU.
- The valve relay, which is integrated in the ABS-ECU, is always energizing the solenoid valve unless the initial check is in progress when the ignition switch is turned on.
- The ABS-ECU activates the solenoid valve by turning on its driving transistor.

ABS DTC SET CONDITIONS

These diagnostic trouble codes will be set under the cases below.

- The solenoid valve is not energized even after the ABS-ECU has turned on the driving transistor (Open circuit is present in the power supply circuit to the ABS-ECU solenoid valve, or the valve relay has failed).

- The solenoid valve is not energized even after the ABS-ECU has turned on the driving transistor (Open circuit is present in the solenoid valve circuit inside the ABS-ECU, or the valve relay has failed).
- After the ABS-ECU has turned off the driving transistor, the solenoid valve still remains energized (short in the solenoid valve circuit).
- When a solenoid valve failure is detected

TROUBLESHOOTING HINTS (THE MOST LIKELY CAUSES FOR THESE DTCS ARE TO SET ARE:)**Current trouble**

- Damaged wiring harness or connector
- Malfunction of the hydraulic unit (integrated with ABS-ECU)

PAST TROUBLE

- Carry out diagnosis with particular emphasis on connector(s) or wiring harness between the power supply circuit (terminal 1) to the ABS-ECU solenoid valve or ground circuit (terminal 2). For diagnosis procedures, refer to "How to treat past trouble" (Refer to GROUP 00, How to treat past trouble P.00-16).

DIAGNOSIS**Required Special Tools:**

- MB991958: Scan Tool (MUT-III Sub Assembly)
 - MB991824: V.C.I.
 - MB991827: MUT-III USB Cable
 - MB991910: MUT-III Main Harness A
- MB991974: ABS Check Harness

STEP 1. Using scan tool MB991958, diagnose the CAN bus line.

⚠ CAUTION

To prevent damage to scan tool MB991958, always turn the ignition switch to the "LOCK" (OFF) position before connecting or disconnecting scan tool MB991958.

- (1) Connect scan tool MB991958 to the data link connector.
- (2) Turn the ignition switch to the "ON" position.
- (3) Diagnose the CAN bus line.
- (4) Turn the ignition switch to the "LOCK" (OFF) position.

Q: Is the CAN bus line found to be normal?

YES : Go to Step 3.

NO : Repair the CAN bus line (Refer to GROUP 54C, Diagnosis P.54C-14). Then go to Step 2.

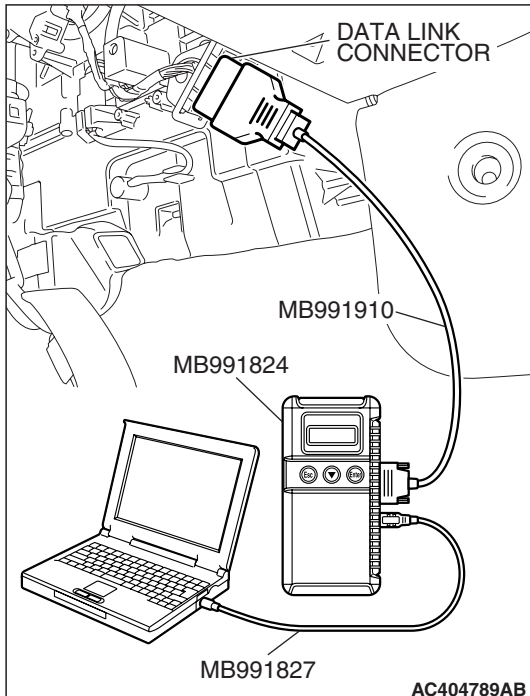

STEP 2. Recheck for diagnostic trouble code.

⚠ CAUTION

To prevent damage to scan tool MB991958, always turn the ignition switch to the "LOCK" (OFF) position before connecting or disconnecting scan tool MB991958.

- (1) Erase the DTC.
- (2) Turn the ignition switch to the "ON" position.
- (3) Check if the DTC is set.
- (4) Turn the ignition switch to the "LOCK" (OFF) position.

Q: Is DTC C1226, C1231, C1236, C1241, C1246, C1251, C1256 or C1261 set?

YES : Go to Step 3.

NO : The procedure is complete.

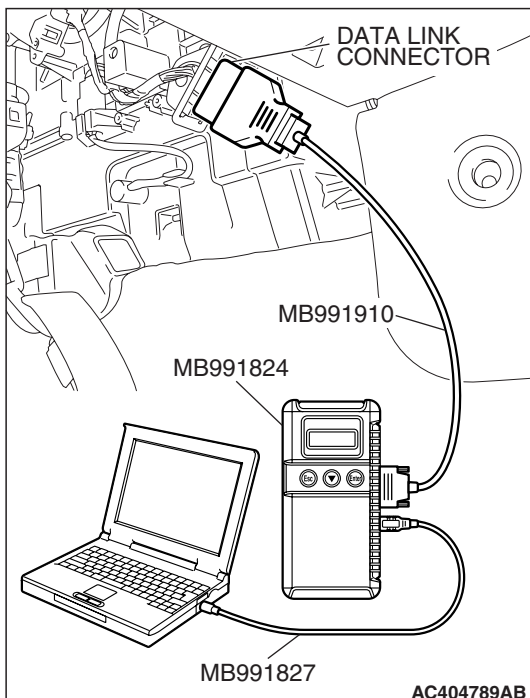

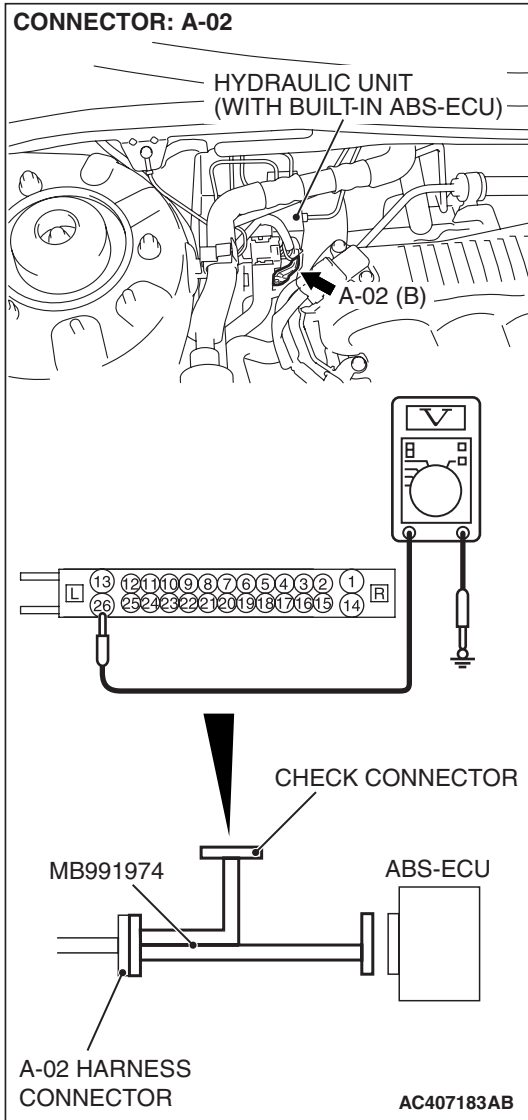

STEP 3. Measure the voltage at ABS-ECU connector A-02.

- (1) Disconnect the connector A-02, and connect special tool MB991974 to the wiring harness-side connector.

NOTE: Do not connect special tool MB991974 to the ABS-ECU.

- (2) Turn the ignition switch to the "ON" position.
- (3) Measure the voltage between terminal 26 and ground. It should be approximately 12 volts (battery positive voltage).

Q: Is the voltage approximately 12 volts (battery positive voltage)?

YES : Go to Step 5.

NO : Go to Step 4.

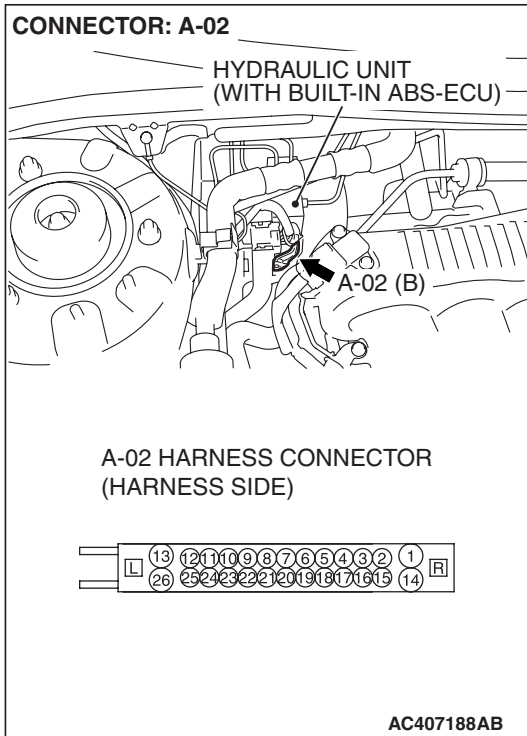

STEP 4. Check ABS-ECU connector A-02 for loose, corroded or damaged terminals, or terminals pushed back in the connector.

Q: Is ABS-ECU connector A-02 damaged?

YES : Repair or replace the damaged component(s). Refer to GROUP 00E, Harness Connector Inspection

[P.00E-2](#). Then go to Step 8.

NO : An open or short circuit may be present in the solenoid valve power supply circuit. Repair the wiring harness between ABS-ECU connector A-02 terminal 26 and fusible link No.3. Then go to Step 8.

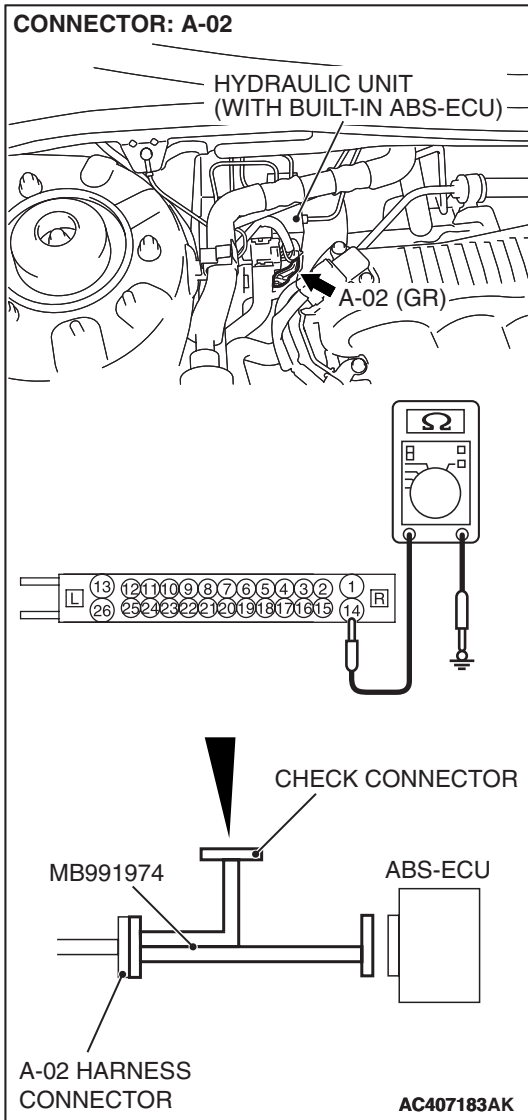

STEP 5. Measure the resistance at ABS-ECU connector A-02.

(1) Disconnect the connector A-02, and connect special tool MB991974 to the wiring harness-side connector.

NOTE: Do not connect special tool MB991974 to the ABS-ECU.

(2) Measure the resistance between terminal 14 and ground. It should be 2 ohms or less.

Q: Is the measured resistance 2 ohms or less?

YES : Go to Step 7.

NO : Go to Step 6.

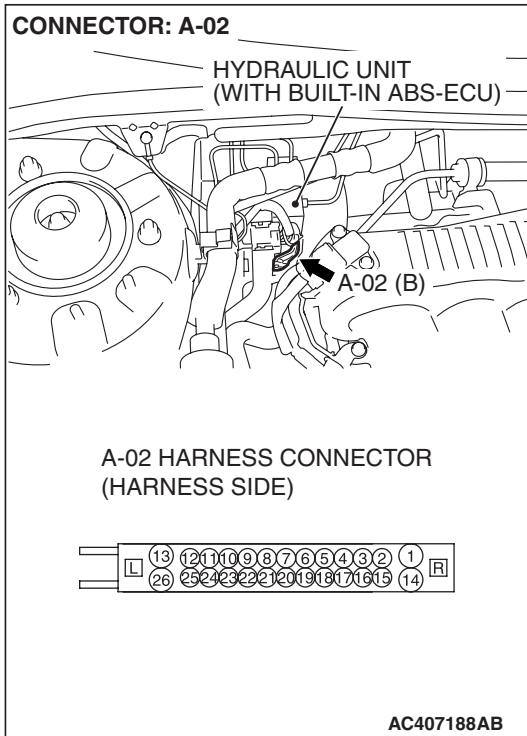

STEP 6. Check ABS-ECU connector A-02 for loose, corroded or damaged terminals, or terminals pushed back in the connector.

Q: Is ABS-ECU connector A-02 damaged?

YES : Repair or replace the damaged component(s). Refer to GROUP 00E, Harness Connector Inspection

[P.00E-2](#). Then go to Step 8.

NO : An open circuit may be present in the ground circuit. Repair the wiring harness between ABS-ECU connector A-02 terminal 14 and the body ground. Then go to Step 8.

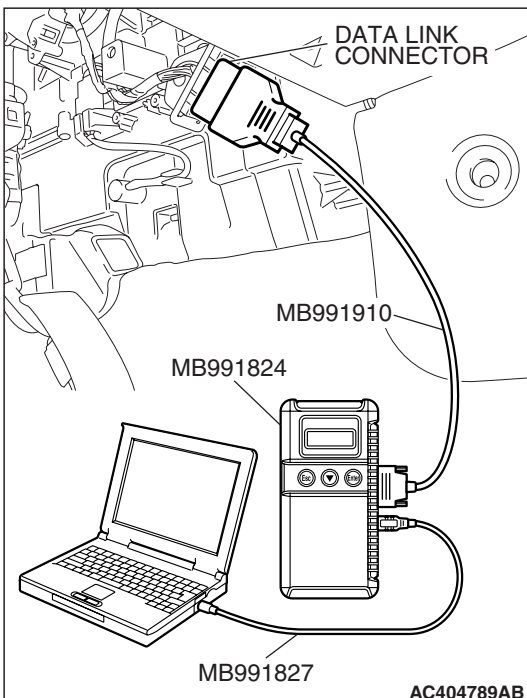

STEP 7. Recheck for diagnostic trouble code.

CAUTION

To prevent damage to scan tool MB991958, always turn the ignition switch to the "LOCK" (OFF) position before connecting or disconnecting scan tool MB991958.

Check again if the DTC is set.

- (1) Turn the ignition switch to the "ON" position.
- (2) Erase the DTC.
- (3) Turn the ignition switch to the "LOCK" (OFF) position.
- (4) Turn the ignition switch to the "ON" position.
- (5) Check if the DTC is set.
- (6) Turn the ignition switch to the "LOCK" (OFF) position.

Q: Is DTC C1226, C1231, C1236, C1241, C1246, C1251, C1256 or C1261 set?

YES : Replace the hydraulic unit (integrated with ABS-ECU). Then go to Step 8.

NO : It can be assumed that this malfunction is intermittent. Refer to GROUP 00, How to Use Troubleshooting/Inspection Service Points –How to Cope with Intermittent Malfunction [P.00-14](#).

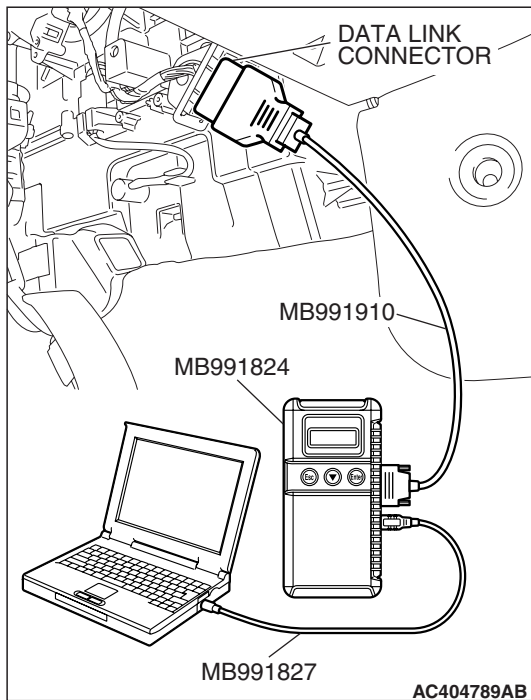
**STEP 8. Recheck for diagnostic trouble code.****⚠ CAUTION**

To prevent damage to scan tool MB991958, always turn the ignition switch to the "LOCK" (OFF) position before connecting or disconnecting scan tool MB991958.

Check again if the DTC is set.

- (1) Turn the ignition switch to the "ON" position.
- (2) Erase the DTC.
- (3) Turn the ignition switch to the "LOCK" (OFF) position.
- (4) Turn the ignition switch to the "ON" position.
- (5) Check if the DTC is set.
- (6) Turn the ignition switch to the "LOCK" (OFF) position.

Q: Is DTC C1226, C1231, C1236, C1241, C1246, C1251, C1256 or C1261 set?

YES : Go to Step 1.

NO : The procedure is complete.

DTC C1271: Motor Circuit Failure

Solenoid Valve and Motor Power Supply Circuit

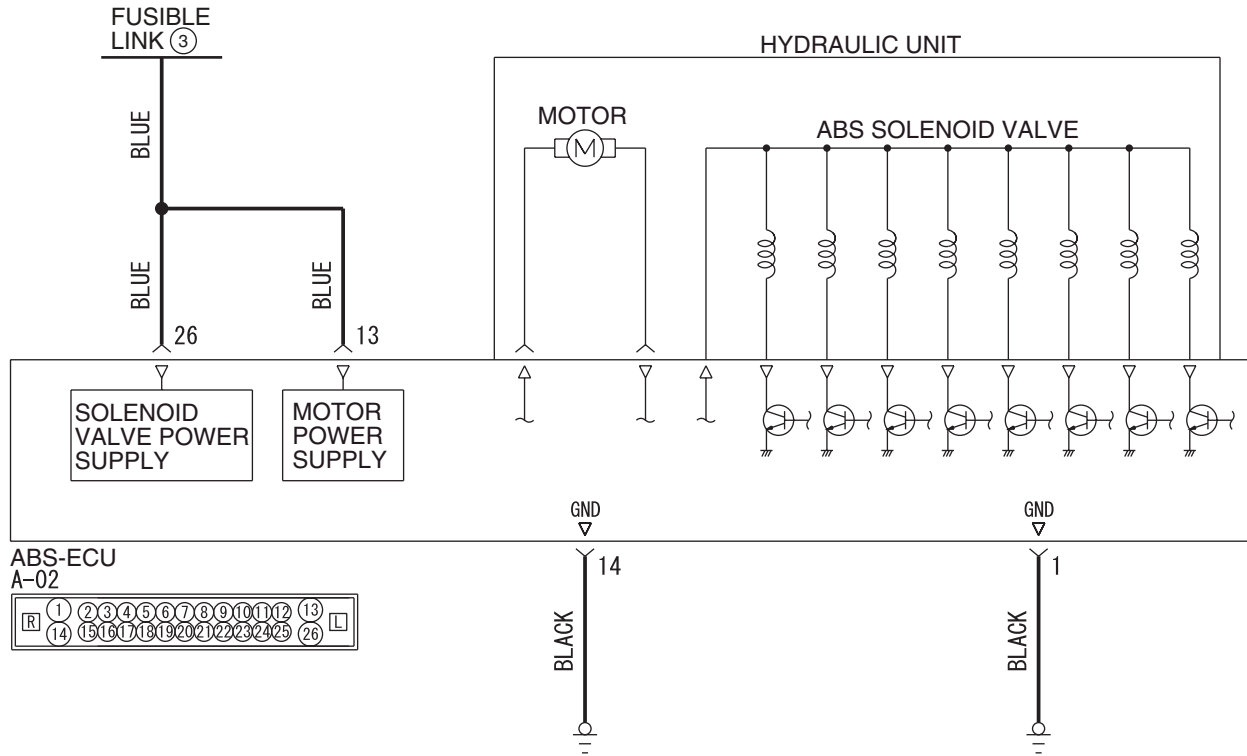

W6P35M002A

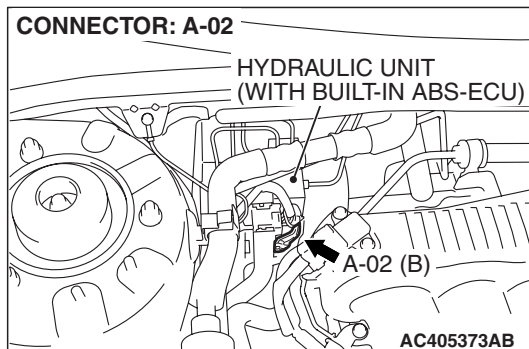

CAUTION

If there is any problem in the CAN bus lines, an incorrect diagnostic trouble code may be set. Prior to this diagnosis, diagnose the CAN bus lines.

CIRCUIT OPERATION

- The ABS-ECU contains the power supply circuit (terminal 13) for the pump motor. The pump motor is energized by the motor relay, which is integrated in the ABS-ECU.

- The motor relay, which is integrated in the ABS-ECU, is always off unless the motor solenoid valve check is activated when the vehicle is started.
- The ABS-ECU activates the pump motor by turning on the ECU built-in motor relay when the ABS is working.

ABS DTC SET CONDITIONS

This diagnostic trouble code will be set under the cases below.

- When the voltage supplied to the pump motor is too low.
- When the voltage supplied to the pump motor is too high.
- When the ABS-ECU judges that the voltage is supplied to the pump motor while the pump motor is stopped.

TROUBLESHOOTING HINTS (The most likely causes for these DTCs are to set are:)**Current trouble**

- Damaged wiring harness or connector

- Malfunction of the hydraulic unit (integrated with ABS-ECU)

Past trouble

- Carry out diagnosis with particular emphasis on connector(s) or wiring harness between the power supply circuit (terminal 13) to the ABS-ECU motor or ground circuit (terminal 1). For diagnosis procedures, refer to "How to treat past trouble" (Refer to GROUP 00, How to treat past trouble [P.00-16](#)).

DIAGNOSIS**Required Special Tools:**

- MB991958: Scan Tool (MUT-III Sub Assembly)
 - MB991824: V.C.I.
 - MB991827: MUT-III USB Cable
 - MB991910: MUT-III Main Harness A
- MB991974: ABS Check Harness

STEP 1. Using scan tool MB991958, diagnose the CAN bus line.**⚠ CAUTION**

To prevent damage to scan tool MB991958, always turn the ignition switch to the "LOCK" (OFF) position before connecting or disconnecting scan tool MB991958.

- (1) Connect scan tool MB991958 to the data link connector.
- (2) Turn the ignition switch to the "ON" position.
- (3) Diagnose the CAN bus line.
- (4) Turn the ignition switch to the "LOCK" (OFF) position.

Q: Is the CAN bus line found to be normal?

YES : Go to Step 3.

NO : Repair the CAN bus line (Refer to GROUP 54C, Diagnosis [P.54C-14](#)). Then go to Step 2.

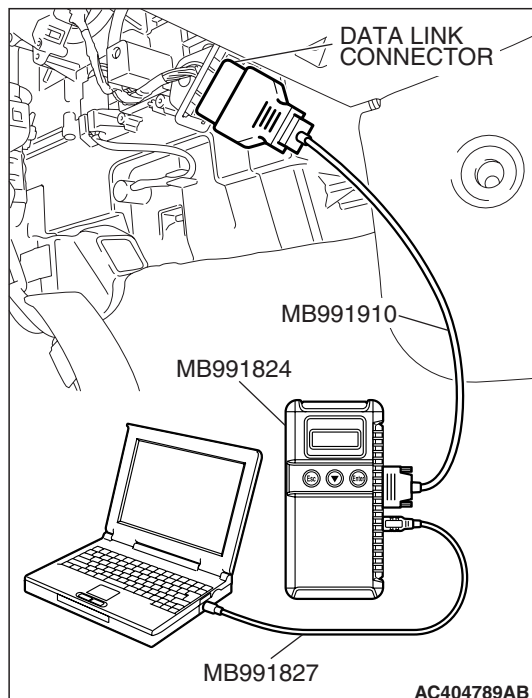

STEP 2. Recheck for diagnostic trouble code.

⚠ CAUTION

To prevent damage to scan tool MB991958, always turn the ignition switch to the "LOCK" (OFF) position before connecting or disconnecting scan tool MB991958.

- (1) Turn the ignition switch to the "ON" position.
- (2) Erase the DTC.
- (3) Turn the ignition switch to the "LOCK" (OFF) position.
- (4) Turn the ignition switch to the "ON" position.
- (5) Check if the DTC is set.
- (6) Turn the ignition switch to the "LOCK" (OFF) position.

Q: Is DTC C1271 set?

YES : Go to Step 3.

NO : The procedure is complete.

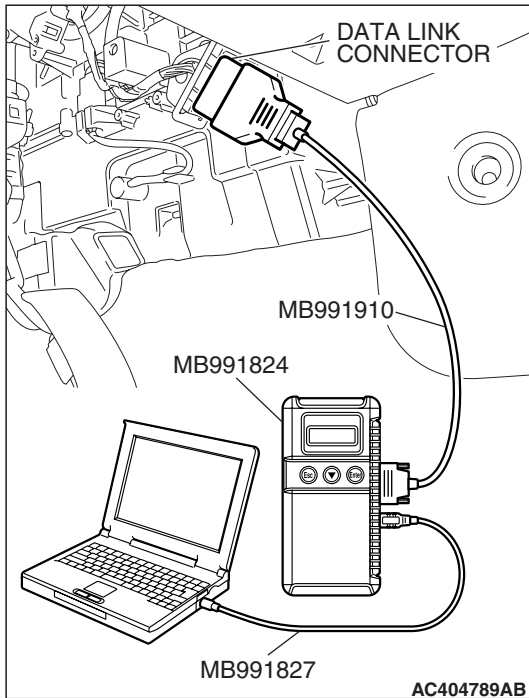

AC404789AB

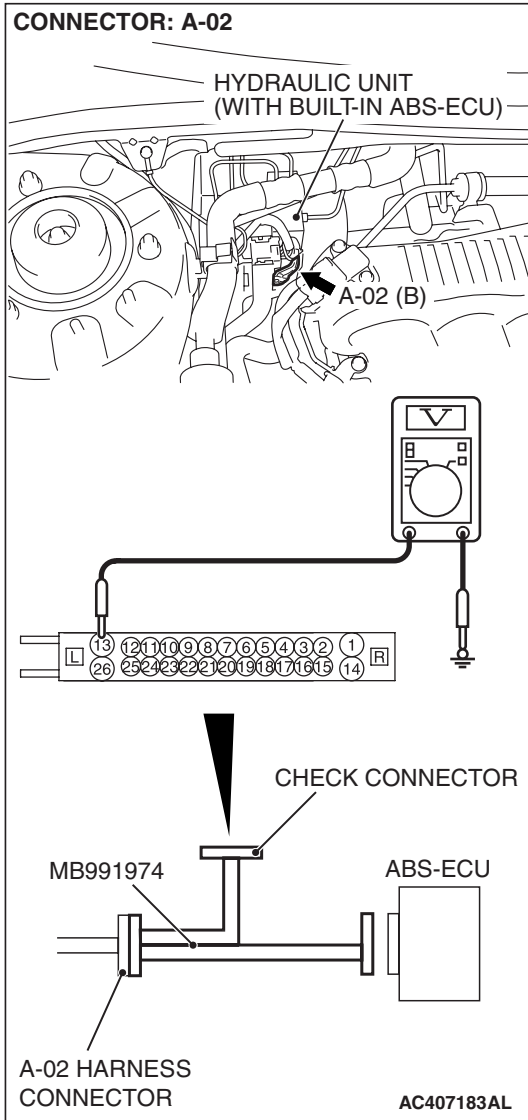

STEP 3. Measure the voltage at ABS-ECU connector A-02.

- (1) Disconnect the connector A-02, and connect special tool MB991974 to the wiring harness-side connector.

NOTE: Do not connect special tool MB991974 to the ABS-ECU.

- (2) Turn the ignition switch to the "ON" position.
- (3) Measure the voltage between terminal 13 and ground. It should be approximately 12 volts (battery positive voltage).

Q: Is the voltage approximately 12 volts (battery positive voltage)?

YES : Go to Step 5.

NO : Go to Step 4.

STEP 4. Check ABS-ECU connector A-02 for loose, corroded or damaged terminals, or terminals pushed back in the connector.

Q: Is ABS-ECU connector A-02 damaged?

YES : Repair or replace the damaged component(s). Refer to GROUP 00E, Harness Connector Inspection

[P.00E-2](#). Then go to Step 8.

NO : An open or short circuit may be present in the solenoid valve power supply circuit. Repair the wiring harness between ABS-ECU connector A-02 terminal 13 and fusible link No.3. Then go to Step 8.

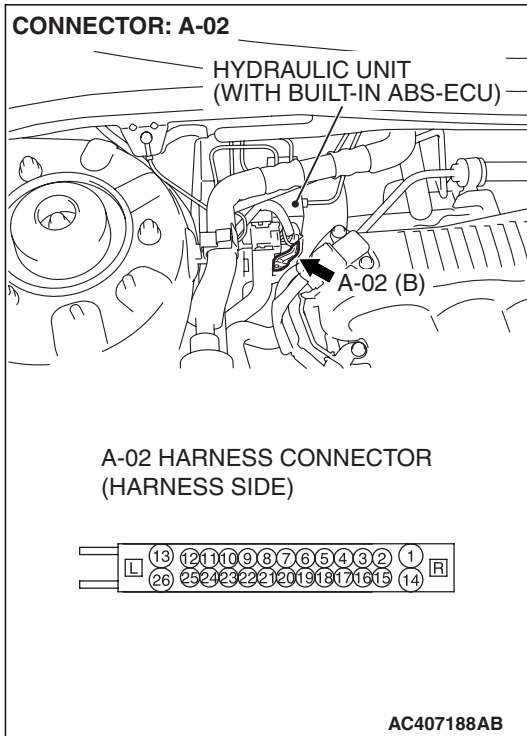

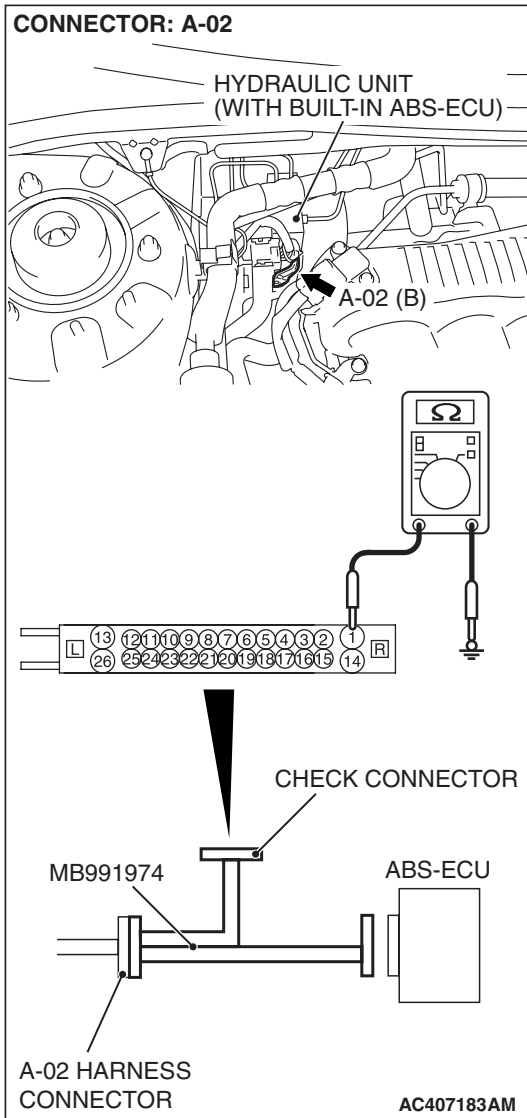

STEP 5. Measure the resistance at ABS-ECU connector A-02.

(1) Disconnect the connector A-02, and connect special tool MB991974 to the wiring harness-side connector.

NOTE: Do not connect special tool MB991974 to the ABS-ECU.

(2) Measure the resistance between terminal 1 and ground. It should be 2 ohms or less.

Q: Is the measured resistance 2 ohms or less?

YES : Go to Step 7.

NO : Go to Step 6.

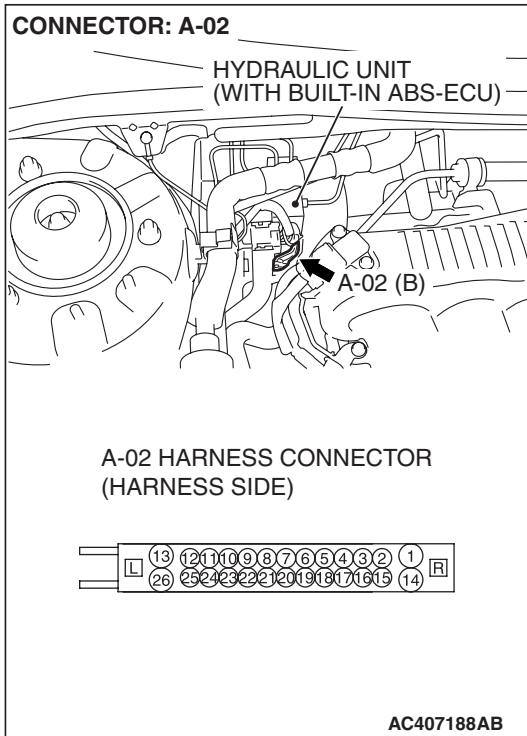

STEP 6. Check ABS-ECU connector A-02 for loose, corroded or damaged terminals, or terminals pushed back in the connector.

Q: Is ABS-ECU connector A-02 damaged?

YES : Repair or replace the damaged component(s). Refer to GROUP 00E, Harness Connector Inspection

[P.00E-2](#). Then go to Step 8.

NO : An open circuit may be present in the ground circuit. Repair the wiring harness between ABS-ECU connector A-02 terminal 13 and the body ground. Then go to Step 8.

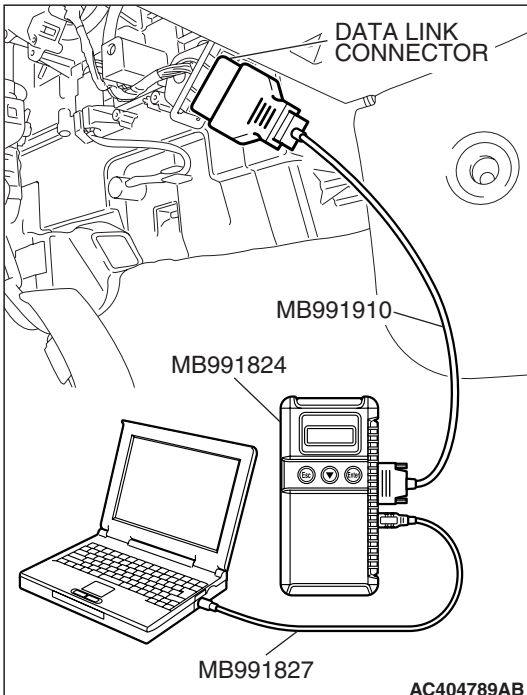

STEP 7. Recheck for diagnostic trouble code.

CAUTION

To prevent damage to scan tool MB991958, always turn the ignition switch to the "LOCK" (OFF) position before connecting or disconnecting scan tool MB991958.

Check again if the DTC is set.

- (1) Turn the ignition switch to the "ON" position.
- (2) Erase the DTC.
- (3) Turn the ignition switch to the "LOCK" (OFF) position.
- (4) Turn the ignition switch to the "ON" position.
- (5) Check if the DTC is set.
- (6) Turn the ignition switch to the "LOCK" (OFF) position.

Q: Is DTC C1271 set?

YES : Replace the hydraulic unit (integrated with ABS-ECU). Then go to Step 8.

NO : It can be assumed that this malfunction is intermittent. Refer to GROUP 00, How to Use Troubleshooting/Inspection Service Points –How to Cope with Intermittent Malfunction [P.00-14](#).

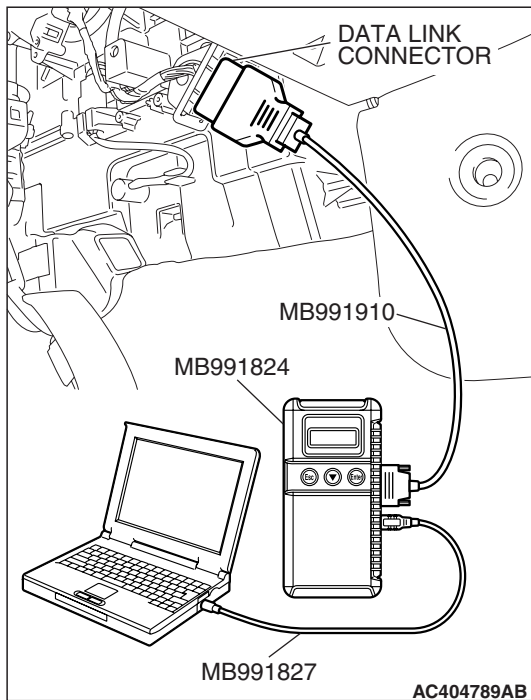
**STEP 8. Recheck for diagnostic trouble code.****⚠ CAUTION**

To prevent damage to scan tool MB991958, always turn the ignition switch to the "LOCK" (OFF) position before connecting or disconnecting scan tool MB991958.

Check again if the DTC is set.

- (1) Turn the ignition switch to the "ON" position.
- (2) Erase the DTC.
- (3) Turn the ignition switch to the "LOCK" (OFF) position.
- (4) Turn the ignition switch to the "ON" position.
- (5) Check if the DTC is set.
- (6) Turn the ignition switch to the "LOCK" (OFF) position.

Q: Is DTC C1271 set?

YES : Go to Step 1.

NO : The procedure is complete.

DTC C1276: Power Supply Circuit Failure of Valves

Solenoid Valve and Motor Power Supply Circuit

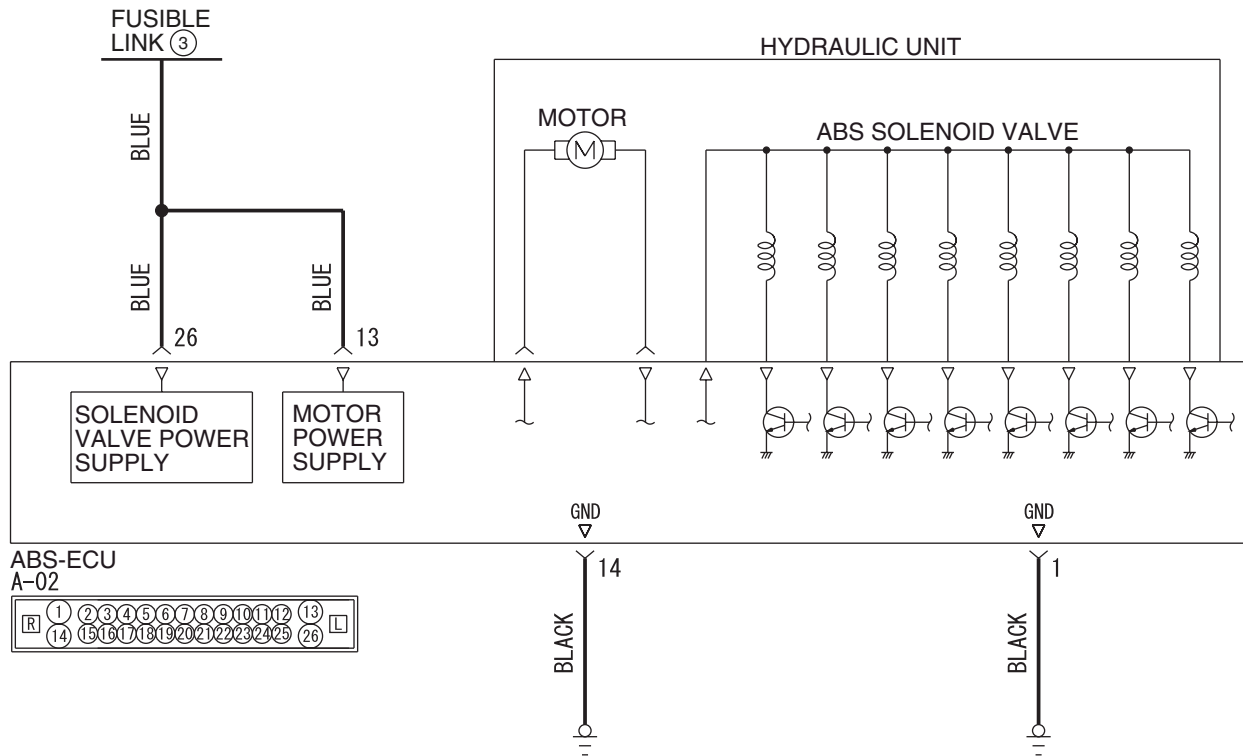

W6P35M002A

CAUTION

If there is any problem in the CAN bus lines, an incorrect diagnostic trouble code may be set. Prior to this diagnosis, diagnose the CAN bus lines. (Refer to GROUP 54C, Trouble code diagnosis P.54C-12).

CIRCUIT OPERATION

- The ABS-ECU contains the power supply circuit (terminal 26) for the solenoid valve. The solenoid valve is energized by the valve relay, which is integrated in the ABS-ECU.
- The valve relay, which is integrated in the ABS-ECU, is always energizing the solenoid valve unless the initial check is in progress when the ignition switch is turned on.

ABS DTC SET CONDITIONS

This diagnostic trouble code will be set under the cases below.

- After the ABS-ECU turned on the valve relay, the solenoid valve is not energized (valve relay OFF failure).

- After the ABS-ECU turned off the valve relay, the solenoid valve still remains energized (valve relay ON failure).

TROUBLESHOOTING HINTS (THE MOST LIKELY CAUSES FOR THESE DTCS ARE TO SET ARE:)

Current trouble

- Damaged wiring harness or connector
- Malfunction of the hydraulic unit (integrated with ABS-ECU)

PAST TROUBLE

Carry out diagnosis with particular emphasis on connector(s) or wiring harness between the power supply circuit (terminal 26) to the ABS-ECU solenoid valve or ground circuit (terminal 14). For diagnosis procedures, refer to "How to treat past trouble" (Refer to GROUP 00, How to treat past trouble P.00-16).

DIAGNOSIS**Required Special Tools:**

- MB991958: Scan Tool (MUT-III Sub Assembly)
 - MB991824: V.C.I.
 - MB991827: MUT-III USB Cable
 - MB991910: MUT-III Main Harness A

STEP 1. Using scan tool MB991958, diagnose the CAN bus line.

⚠ CAUTION

To prevent damage to scan tool MB991958, always turn the ignition switch to the "LOCK" (OFF) position before connecting or disconnecting scan tool MB991958.

- (1) Connect scan tool MB991958 to the data link connector.
- (2) Turn the ignition switch to the "ON" position.
- (3) Diagnose the CAN bus line.
- (4) Turn the ignition switch to the "LOCK" (OFF) position.

Q: Is the CAN bus line found to be normal?

YES : Go to Step 2.

NO : Repair the CAN bus line (Refer to GROUP 54C, Diagnosis [P.54C-14](#)). Then go to Step 2.

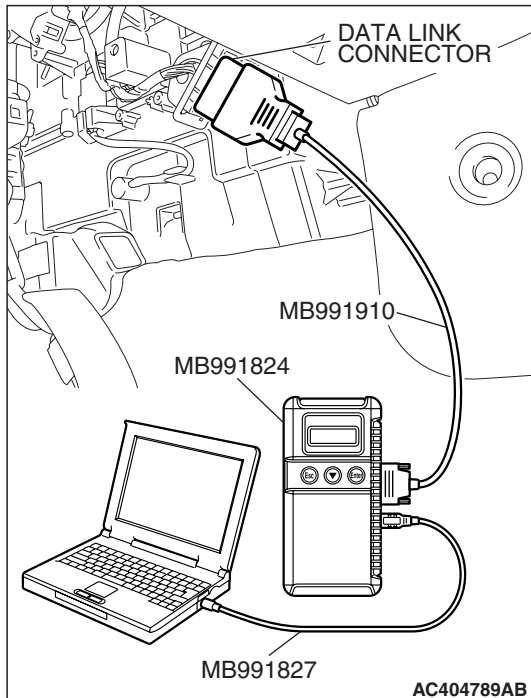

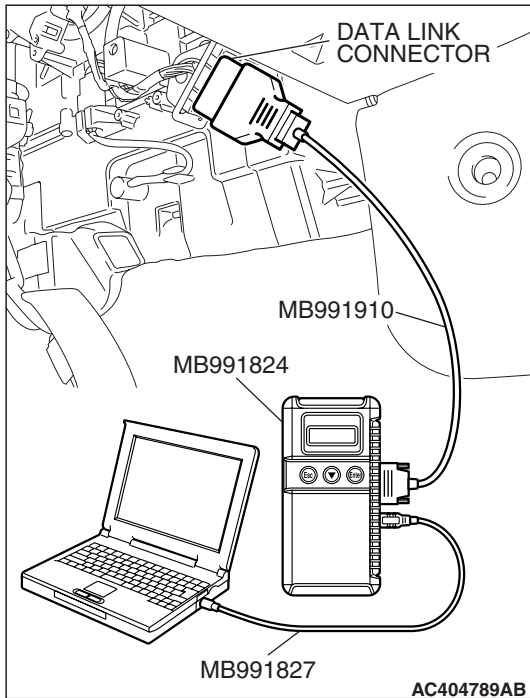

STEP 2. Recheck for diagnostic trouble code.

⚠ CAUTION

To prevent damage to scan tool MB991958, always turn the ignition switch to the "LOCK" (OFF) position before connecting or disconnecting scan tool MB991958.

- (1) Turn the ignition switch to the "ON" position.
- (2) Erase the DTC.
- (3) Turn the ignition switch to the "LOCK" (OFF) position.
- (4) Turn the ignition switch to the "ON" position.
- (5) Check if the DTC is set.
- (6) Turn the ignition switch to the "LOCK" (OFF) position.

Q: Is DTC C1276 set?

YES : Replace the hydraulic unit (integrated with ABS-ECU).

NO : The procedure is complete.

DTC C1607: ECU failure

⚠ CAUTION

If there is any problem in the CAN bus lines, an incorrect diagnostic trouble code may be set. Prior to this diagnosis, diagnose the CAN bus lines. (Refer to GROUP 54C, Trouble code diagnosis P.54C-12).

⚠ CAUTION

Whenever the ECU is replaced, ensure that the CAN bus lines are normal.

ABS DTC SET CONDITIONS

The ABS-ECU always monitors itself while the system is working. If the ECU detects any faults, it will set this DTC.

TROUBLESHOOTING HINTS (THE MOST LIKELY CAUSES FOR THESE DTCS ARE TO SET ARE:)

- Malfunction of the hydraulic unit (integrated with ABS-ECU)

DIAGNOSIS

Required Special Tools:

- MB991958: Scan Tool (MUT-III Sub Assembly)
 - MB991824: V.C.I.
 - MB991827: MUT-III USB Cable
 - MB991910: MUT-III Main Harness A

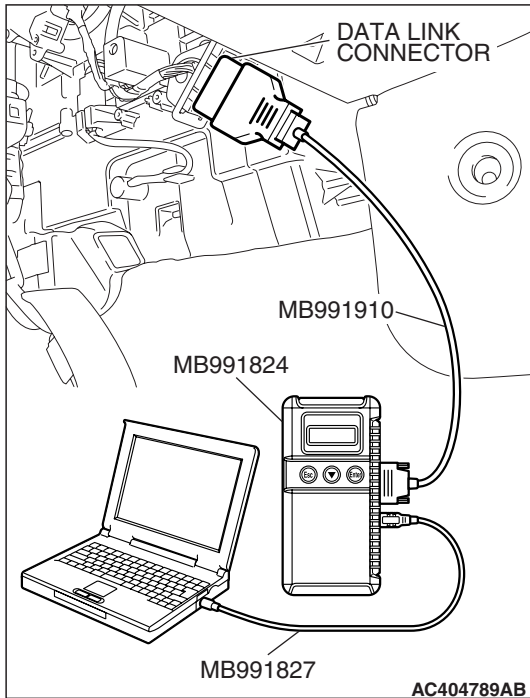

STEP 1. Using scan tool MB991958, diagnose the CAN bus line.

⚠ CAUTION

To prevent damage to scan tool MB991958, always turn the ignition switch to the "LOCK" (OFF) position before connecting or disconnecting scan tool MB991958.

- (1) Connect scan tool MB991958 to the data link connector.
- (2) Turn the ignition switch to the "ON" position.
- (3) Diagnose the CAN bus line.
- (4) Turn the ignition switch to the "LOCK" (OFF) position.

Q: Is the CAN bus line found to be normal?

YES : Go to Step 2.

NO : Repair the CAN bus line (Refer to GROUP 54C, Diagnosis P.54C-14). Then go to Step 2.

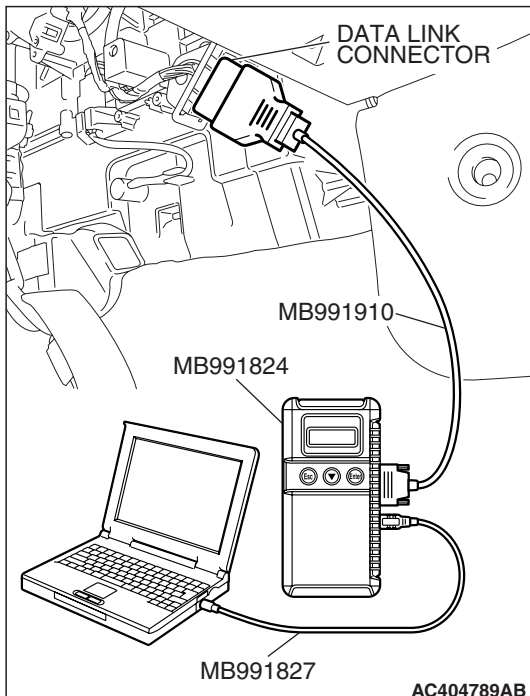

STEP 2. Recheck for diagnostic trouble code.

⚠ CAUTION

To prevent damage to scan tool MB991958, always turn the ignition switch to the "LOCK" (OFF) position before connecting or disconnecting scan tool MB991958.

- (1) Turn the ignition switch to the "ON" position.
- (2) Erase the DTC.
- (3) Turn the ignition switch to the "LOCK" (OFF) position.
- (4) Turn the ignition switch to the "ON" position.
- (5) Check if the DTC is set.
- (6) Turn the ignition switch to the "LOCK" (OFF) position.

Q: Is DTC C1607 set?

YES : Replace the hydraulic unit (integrated with ABS-ECU).

NO : The procedure is complete.

DTC C1860/C1861: Power Supply High Voltage/Power Supply Low Voltage

ABS-ECU Power Supply and Ground Circuit

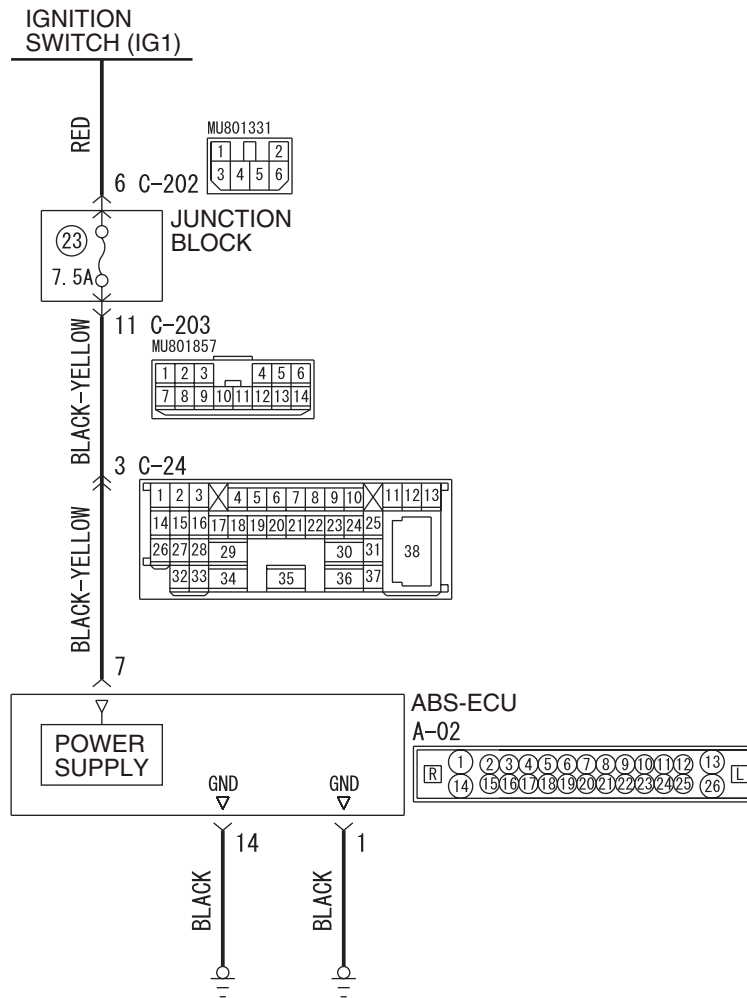

W6P35M015A

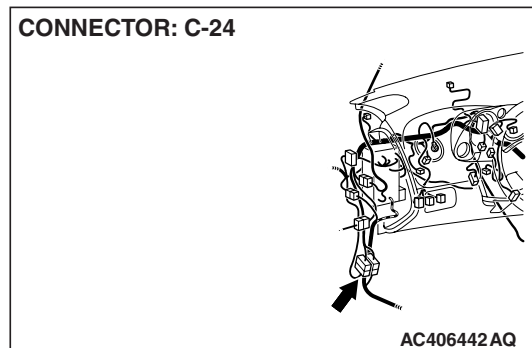
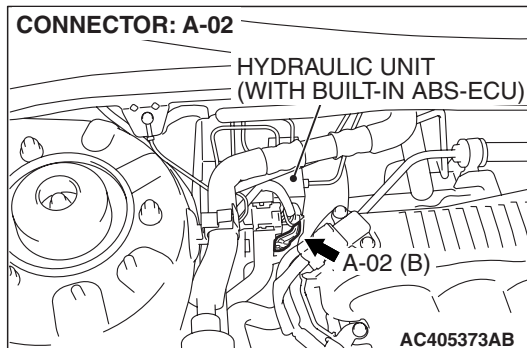

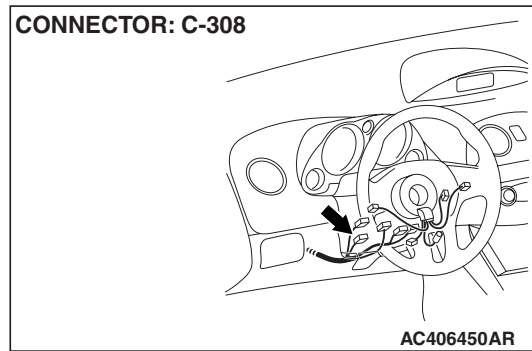
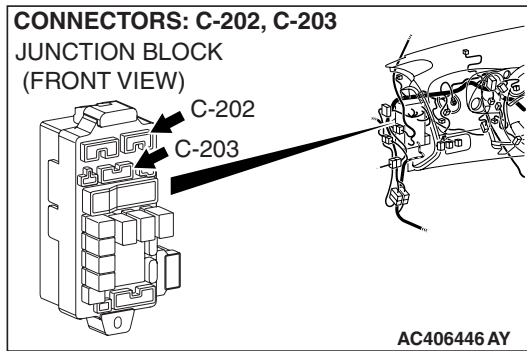

CAUTION

If there is any problem in the CAN bus lines, an incorrect diagnostic trouble code may be set. Prior to this diagnosis, diagnose the CAN bus lines. (Refer to GROUP 54C, Trouble code diagnosis [P.54C-12](#)).

CIRCUIT OPERATION

The ABS-ECU is energized by the ignition switch (IG1) through multi-purpose fuse 23 and the ABS-ECU terminal 20.

ABS DTC SET CONDITIONS

- C1861 will be set when the power supply voltage to the ABS-ECU has decreased to a predetermined value or lower.
- C1860 will be set when the power supply voltage to the ABS-ECU has increased to a predetermined value or higher.

TROUBLESHOOTING HINTS (THE MOST LIKELY CAUSES FOR THESE DTCS ARE TO SET ARE:)

Correct trouble

- Excessive electrical load
- Defective battery
- Damaged wiring harness or connector
- Malfunction of the hydraulic unit (integrated with ABS-ECU)
- Charging system failed

PAST TROUBLE

Carry out diagnosis with particular emphasis on connector(s) or wiring harness in the power supply circuit (terminal 7) to the ABS-ECU. For diagnosis procedures, refer to "How to treat past trouble" (Refer to GROUP 00, How to treat past trouble [P.00-16](#)).

DIAGNOSIS

Required Special Tools:

- MB991958: Scan Tool (MUT-III Sub Assembly)
 - MB991824: V.C.I.
 - MB991827: MUT-III USB Cable
 - MB991910: MUT-III Main Harness A
- MB991974: ABS Check Harness

STEP 1. Using scan tool MB991958, diagnose the CAN bus line.

⚠ CAUTION

To prevent damage to scan tool MB991958, always turn the ignition switch to the "LOCK" (OFF) position before connecting or disconnecting scan tool MB991958.

- (1) Connect scan tool MB991958 to the data link connector.
- (2) Turn the ignition switch to the "ON" position.
- (3) Diagnose the CAN bus line.
- (4) Turn the ignition switch to the "LOCK" (OFF) position.

Q: Is the CAN bus line found to be normal?

YES : Go to Step 3.

NO : Repair the CAN bus line (Refer to GROUP 54C, Diagnosis P.54C-14). Then go to Step 2.

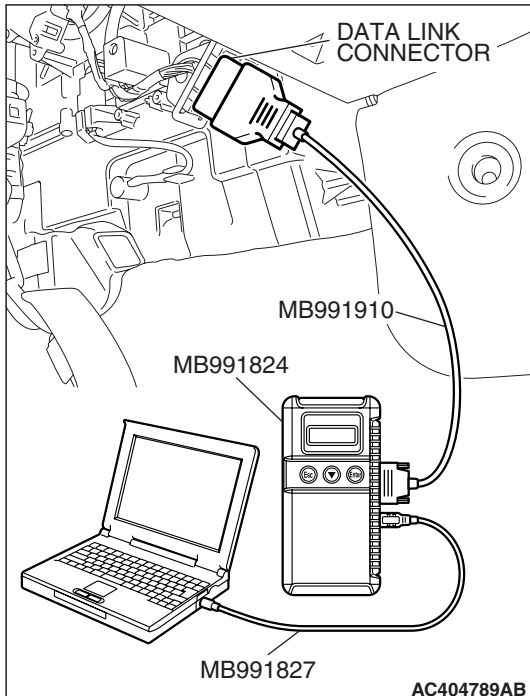

STEP 2. Recheck for diagnostic trouble code.

⚠ CAUTION

To prevent damage to scan tool MB991958, always turn the ignition switch to the "LOCK" (OFF) position before connecting or disconnecting scan tool MB991958.

- (1) Turn the ignition switch to the "ON" position.
- (2) Erase the DTC.
- (3) Turn the ignition switch to the "LOCK" (OFF) position.
- (4) Turn the ignition switch to the "ON" position.
- (5) Check if the DTC is set.
- (6) Turn the ignition switch to the "LOCK" (OFF) position.

Q: Is DTC C1860 or C1861 set?

YES : Go to Step 3.

NO : The procedure is complete.

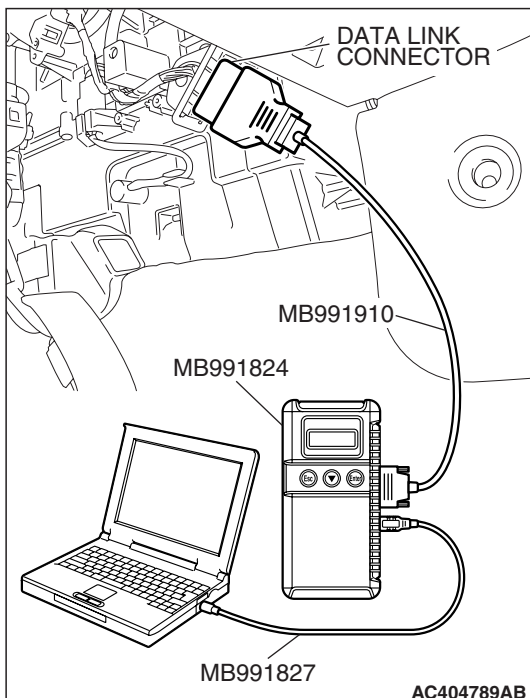

STEP 3. Check the battery.

Check the battery (Refer to GROUP 54A, Battery test P.54A-6).

Q: Is the battery in good condition?

YES : Go to Step 4.

NO : Charge or replace the battery. Then go to Step 8.

STEP 4. Check the charging system.

Check the charging system (Refer to GROUP 16, Charging system diagnosis P.16-4).

Q: Is the charging system in good condition?

YES : Go to Step 5.

NO : Repair or replace the charging system component(s). Then go to Step 8.

STEP 5. Measure the voltage at ABS-ECU connector A-02.

- (1) Disconnect the connector A-02, and connect special tool MB991974 to the wiring harness-side connector.

NOTE: Do not connect special tool MB991974 to the ABS-ECU.

- (2) Turn the ignition switch to the "ON" position.
- (3) Measure the voltage between terminal 7 and ground. It should be approximately 12 volts (battery positive voltage).

Q: Is the voltage approximately 12 volts (battery positive voltage)?

YES : Go to Step 7.

NO : Go to Step 6.

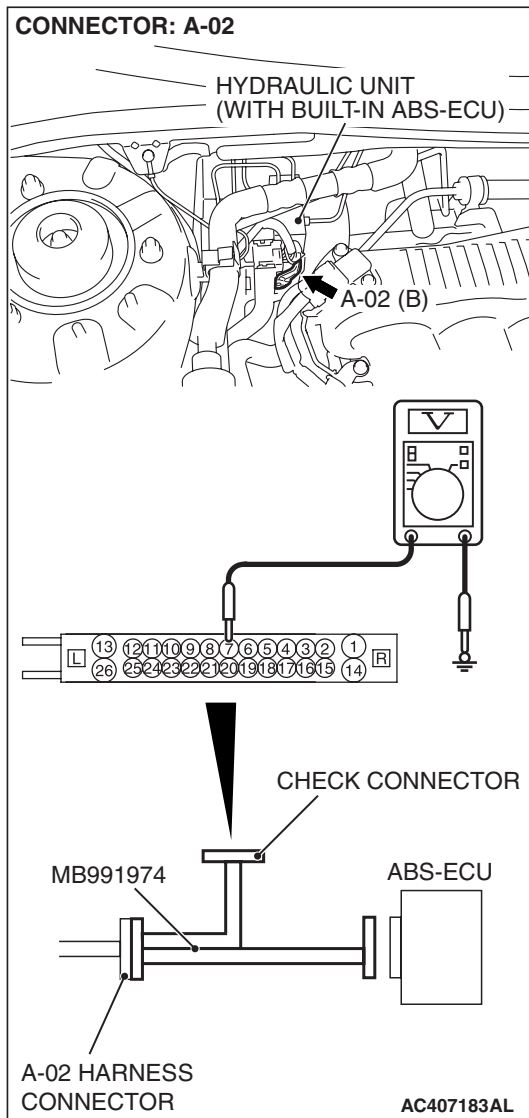

STEP 6. Check ABS-ECU connector A-02, intermediate connector C-24, junction block connectors C-202, C-203 and ignition switch connector C-318 for loose, corroded or damaged terminals, or terminals pushed back in the connector.

- ABS-ECU connector A-02

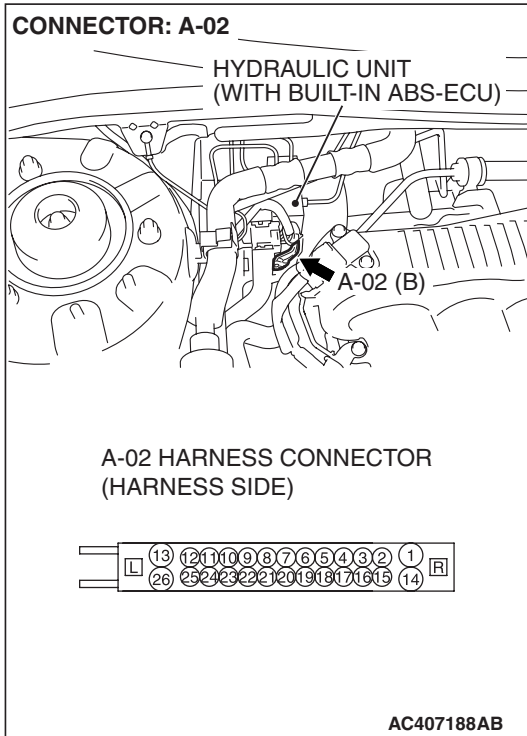

- Intermediate connector C-24

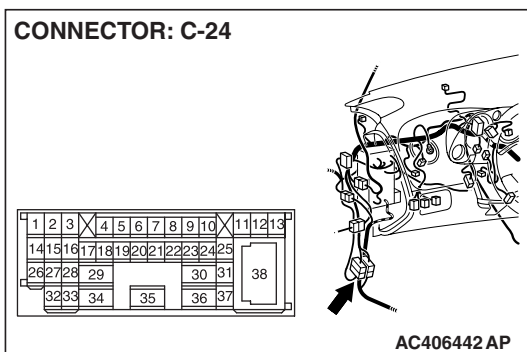

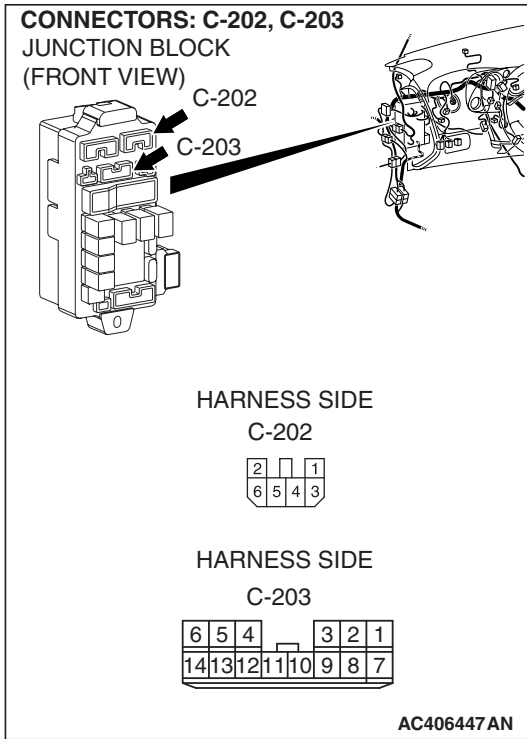

- Junction block connectors C-202 and C-203

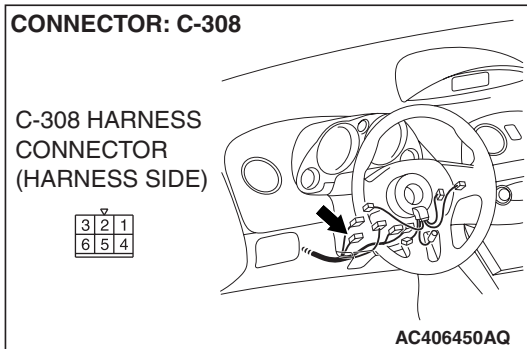

- Ignition switch connector C-308

Q: Are the connectors and terminals in good condition?

YES : An open or short circuit may be present in the power supply line to the ABS-ECU. Repair the wiring harness between ABS-ECU connector A-02 terminal 7 and ignition switch connector C-308 terminal 4. Go to Step 8.

NO : Repair or replace the damaged component(s). Refer to GROUP 00E, Harness Connector Inspection [P.00E-2](#). Then go to Step 8.

STEP 7. Recheck for diagnostic trouble code.

⚠ CAUTION

To prevent damage to scan tool MB991958, always turn the ignition switch to the "LOCK" (OFF) position before connecting or disconnecting scan tool MB991958.

Check again if the DTC is set.

- (1) Turn the ignition switch to the "ON" position.
- (2) Erase the DTC.
- (3) Turn the ignition switch to the "LOCK" (OFF) position.
- (4) Turn the ignition switch to the "ON" position.
- (5) Check if the DTC is set.
- (6) Turn the ignition switch to the "LOCK" (OFF) position.

Q: Is DTC C1860 or C1861 set?

YES : Replace the hydraulic unit (integrated with ABS-ECU). Then go to Step 8.

NO : It can be assumed that this malfunction is intermittent. Refer to GROUP 00, How to Use Troubleshooting/Inspection Service Points –How to Cope with Intermittent Malfunction P.00-14.

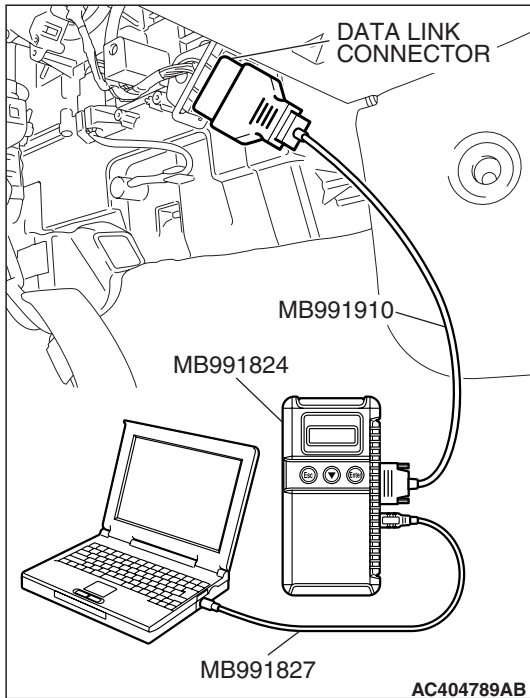

STEP 8. Recheck for diagnostic trouble code.

⚠ CAUTION

To prevent damage to scan tool MB991958, always turn the ignition switch to the "LOCK" (OFF) position before connecting or disconnecting scan tool MB991958.

Check again if the DTC is set.

- (1) Turn the ignition switch to the "ON" position.
- (2) Erase the DTC.
- (3) Turn the ignition switch to the "LOCK" (OFF) position.
- (4) Turn the ignition switch to the "ON" position.
- (5) Check if the DTC is set.
- (6) Turn the ignition switch to the "LOCK" (OFF) position.

Q: Is DTC C1860 or C1861 set?

YES : Go to Step 1.

NO : The procedure is complete.

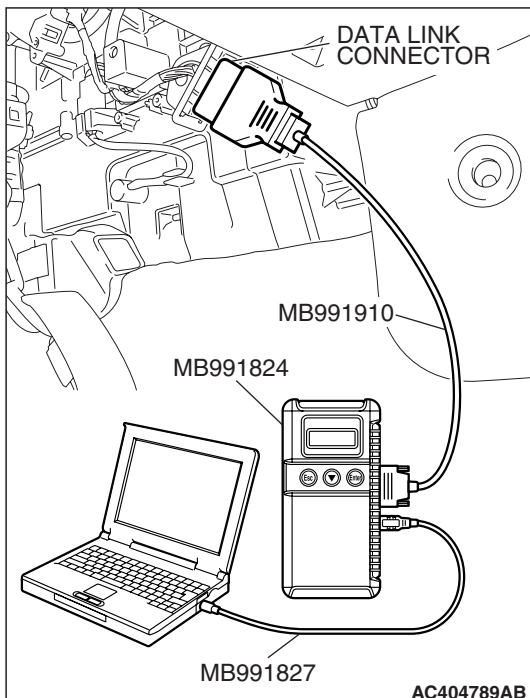

DTC U1073: Bus off

CAUTION

- If DTC U1073 is set in the ABS-ECU, always diagnose the CAN main bus line. If there is any fault in the CAN bus lines, an incorrect DTC may be set.
- Whenever the ECU is replaced, ensure that the communication circuit is normal.

TROUBLE JUDGMENT

This code is stored when the ABS-ECU has ceased the CAN communication (bus off). Then, if a penalty mode is entered after approximately five minutes, the regular data transaxle from the ABS-ECU will be cancelled.

TROUBLESHOOTING HINTS (THE MOST LIKELY CAUSES FOR THESE DTCS ARE TO SET ARE:)

- Damaged wiring harness or connector
- Malfunction of the hydraulic unit (integrated with ABS-ECU)

DIAGNOSIS**Required Special Tools:**

- MB991958: Scan Tool (MUT-III Sub Assembly)
 - MB991824: V.C.I.
 - MB991827: MUT-III USB Cable
 - MB991910: MUT-III Main Harness A

STEP 1. Using scan tool MB991958, diagnose the CAN bus line.**CAUTION**

To prevent damage to scan tool MB991958, always turn the ignition switch to the "LOCK" (OFF) position before connecting or disconnecting scan tool MB991958.

- (1) Connect scan tool MB991958 to the data link connector.
- (2) Turn the ignition switch to the "ON" position.
- (3) Diagnose the CAN bus line.
- (4) Turn the ignition switch to the "LOCK" (OFF) position.

Q: Is the CAN bus line found to be normal?

YES : Go to Step 2.

NO : Repair the CAN bus line (Refer to GROUP 54C, Diagnosis P.54C-14). Then go to Step 2.

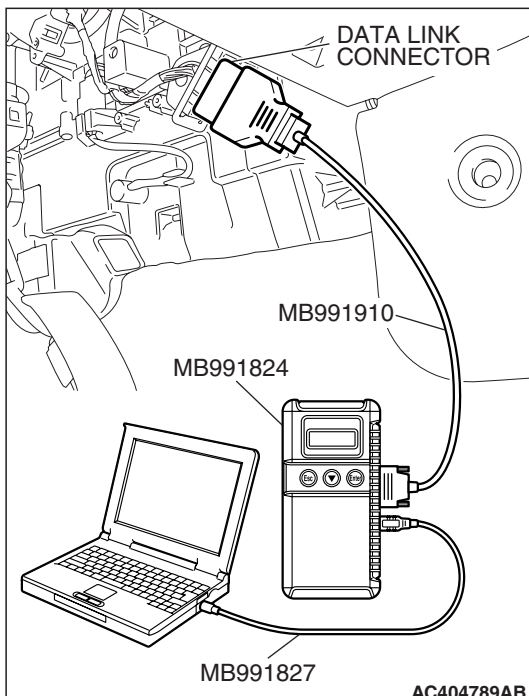

STEP 2. Recheck for diagnostic trouble code.

⚠ CAUTION

To prevent damage to scan tool MB991958, always turn the ignition switch to the "LOCK" (OFF) position before connecting or disconnecting scan tool MB991958.

Check again if the DTC is set.

- (1) Turn the ignition switch to the "ON" position.
- (2) Erase the DTC.
- (3) Turn the ignition switch to the "LOCK" (OFF) position.
- (4) Turn the ignition switch to the "ON" position.
- (5) Check if the DTC is set.
- (6) Turn the ignition switch to the "LOCK" (OFF) position.

Q: Is DTC U1073 set?

YES : Replace the ABS-ECU. Then go to Step 3.

NO : It can be assumed that this malfunction is intermittent. Refer to GROUP 00, How to Use Troubleshooting/Inspection Service Points –How to Cope with Intermittent Malfunction P.00-14.

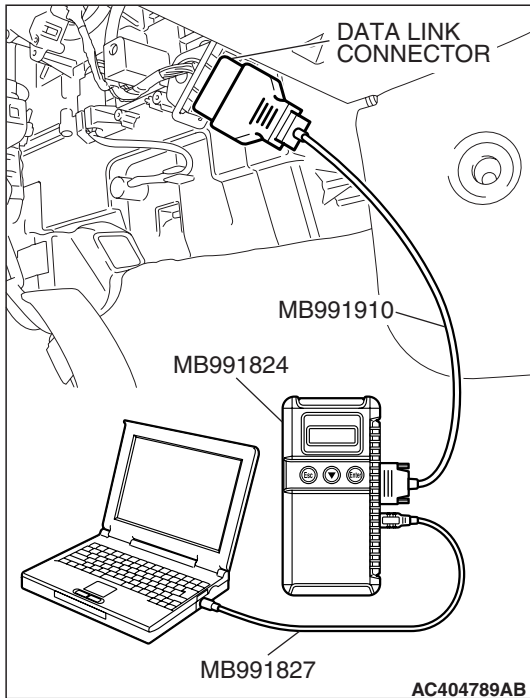

STEP 3. Recheck for diagnostic trouble code.

⚠ CAUTION

To prevent damage to scan tool MB991958, always turn the ignition switch to the "LOCK" (OFF) position before connecting or disconnecting scan tool MB991958.

Check again if the DTC is set.

- (1) Turn the ignition switch to the "ON" position.
- (2) Erase the DTC.
- (3) Turn the ignition switch to the "LOCK" (OFF) position.
- (4) Turn the ignition switch to the "ON" position.
- (5) Check if the DTC is set.
- (6) Turn the ignition switch to the "LOCK" (OFF) position.

Q: Is DTC U1073 set?

YES : Go to Step 1.

NO : The procedure is complete.

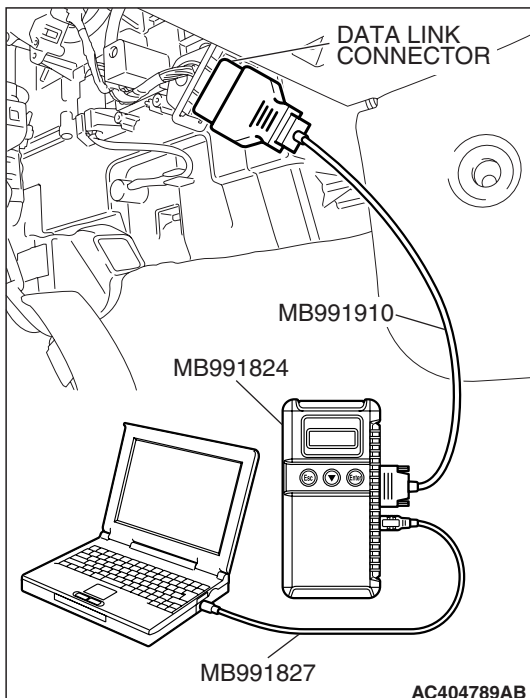

SYMPTOM CHART

M1352011400921

⚠ CAUTION

During diagnosis, a DTC code associated with another system may be set when the ignition switch is turned on with connector(s) disconnected. On completion, confirm all systems for DTC code(s). If DTC code(s) are set, erase them all.

NOTE: If steering movements are made when driving at high speed, or when driving on slippery road, or when passing over bumps, the ABS may operate although sudden braking is not being applied by the driver. Because of this, when getting information from the customer, check if the problem occurred while driving under such conditions as these.

NOTE: During ABS operation, the brake pedal may vibrate a little or may not be able to be pressed. Such conditions are due to intermittent changes in hydraulic pressure inside the brake line to prevent the wheels from locking. This is normal.

SYMPTOM	INSPECTION PROCEDURE NO.	REFERENCE PAGE
Communication between the scan tool and the ABS-ECU is not possible.	1	P.35B-117
ABS-ECU power supply circuit system	2	P.35B-119
When the ignition key is turned to "ON" (Engine stopped), the ABS warning light does not illuminate.	3	P.35B-127
The ABS warning light remains illuminated after the engine is started.	4	P.35B-127
Faulty ABS operation	5	P.35B-130

SYMPTOM PROCEDURES

INSPECTION PROCEDURE 1: Communication between the Scan Tool and the ABS-ECU is not possible.

Data Link Connector Circuit

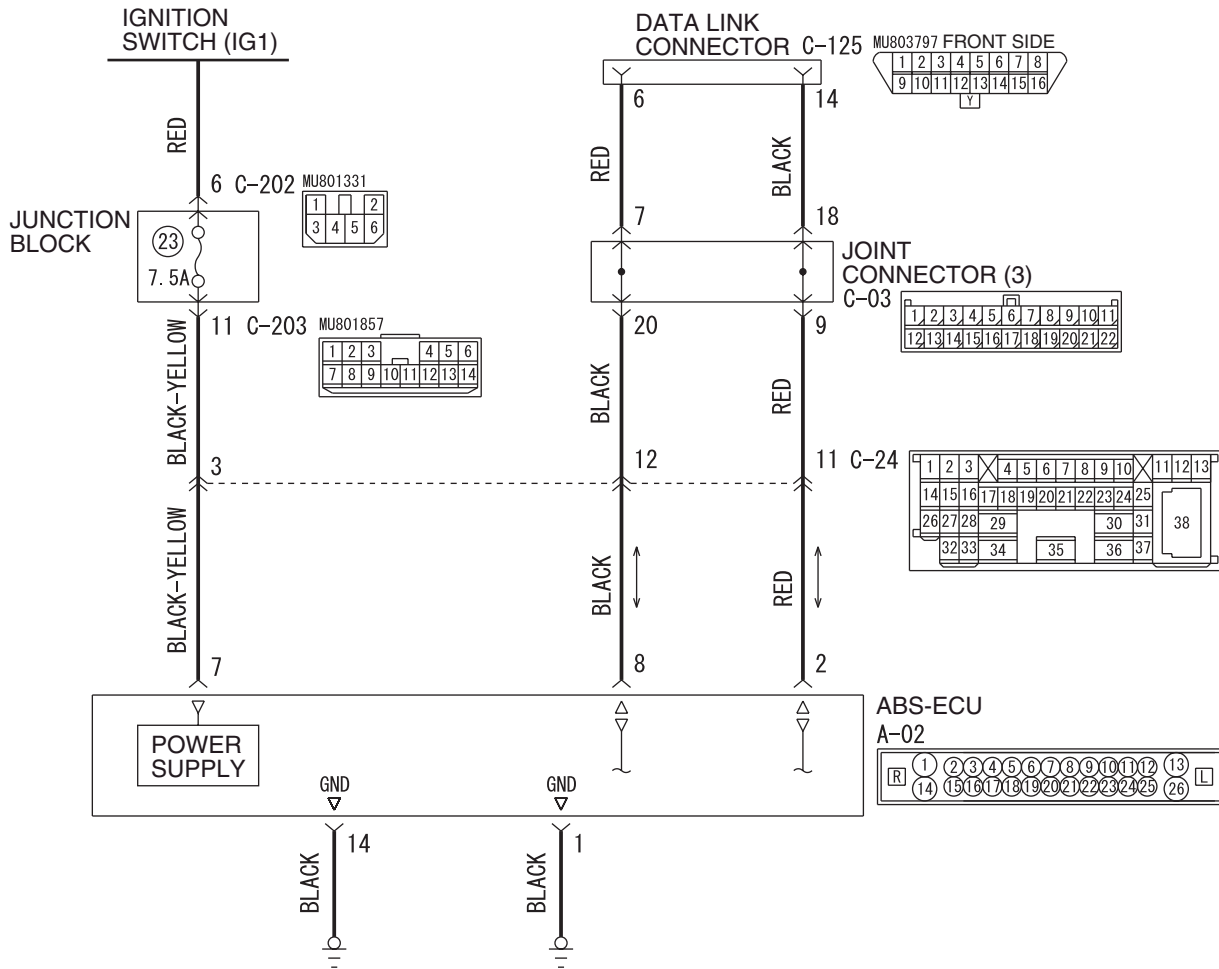

W6P35M013A

TECHNICAL DESCRIPTION (COMMENT)

If the scan tool (MUT-III Sub Assembly) cannot communicate with the ABS system, the CAN bus lines may be defective. If the ABS system does not work, the ABS-ECU or its power supply circuit may be defective.

TROUBLESHOOTING HINTS (THE MOST LIKELY CAUSES FOR THIS CASE:)

- Damaged wiring harness or connector
- Malfunction of the hydraulic unit (Integrated with ABS-ECU)

DIAGNOSIS**Required Special Tools:**

- MB991958: Scan Tool (MUT-III Sub Assembly)
 - MB991824: V.C.I.
 - MB991827: MUT-III USB Cable
 - MB991910: MUT-III Main Harness A

Using scan tool MB991958, diagnose the CAN bus line.

⚠ CAUTION

To prevent damage to scan tool MB991958, always turn the ignition switch to the "LOCK" (OFF) position before connecting or disconnecting scan tool MB991958.

Use scan tool MB991958 to diagnose the CAN bus lines.

- (1) Connect scan tool MB991958 to the data link connector.
- (2) Turn the ignition switch to the "ON" position.
- (3) Diagnose the CAN bus line.

Q: Is the check result satisfactory?

- YES** : Check and repair the power supply circuit system (Refer to [P.35B-119](#)).
- NO** : Repair the CAN bus line (Refer to GROUP 54C, Diagnosis [P.54C-14](#)).

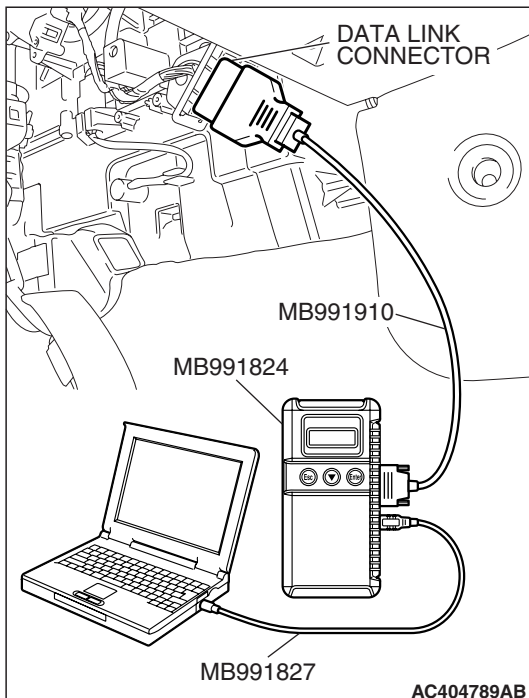

INSPECTION PROCEDURE 2: ABS-ECU Power Supply Circuit System

ABS-ECU Power Supply and Ground Circuit

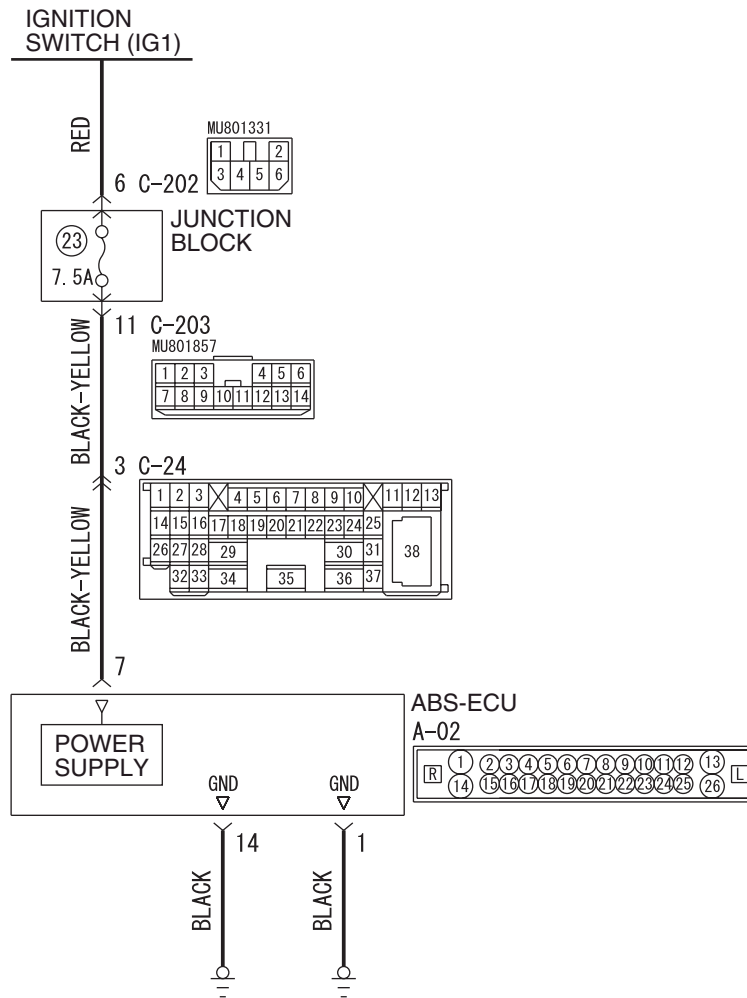

W6P35M015A

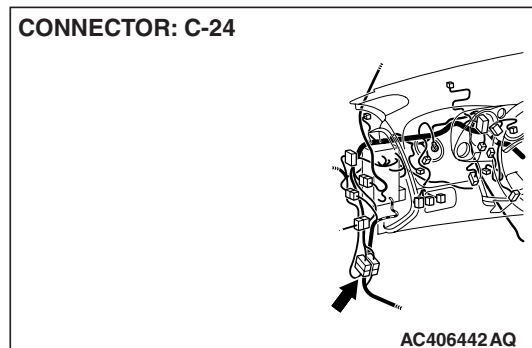
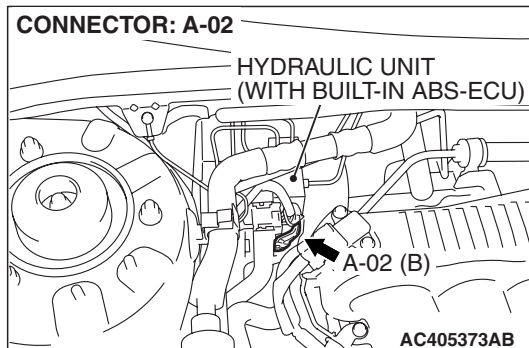

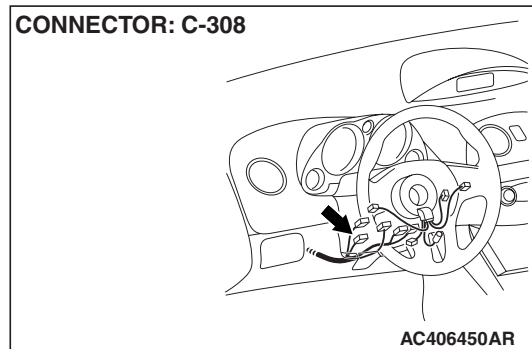
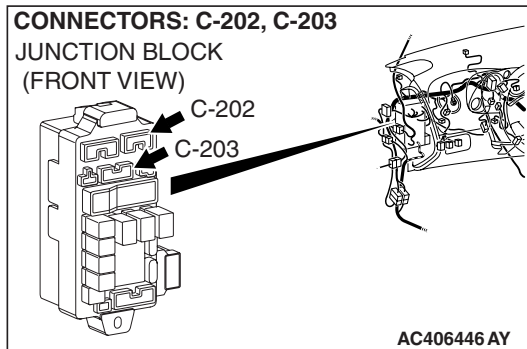

CIRCUIT OPERATION

- The ABS-ECU is energized by the ignition switch (IG1) through multi-purpose fuse 23 and the ABS-ECU terminal 7.
- If the power supply to the ABS-ECU has failed, scan tool (MUT-III Sub Assembly) will not be able to communicate with it.

TROUBLESHOOTING HINTS (THE MOST LIKELY CAUSES FOR THIS CASE:)

- Damaged wiring harness or connector
- Defective battery
- Charging system failed
- Malfunction of the hydraulic unit (integrated with ABS-ECU)

DIAGNOSIS

Required Special Tools:

- MB991958: Scan Tool (MUT-III Sub Assembly)
 - MB991824: V.C.I.
 - MB991827: MUT-III USB Cable
 - MB991910: MUT-III Main Harness A
- MB991974: ABS Check Harness

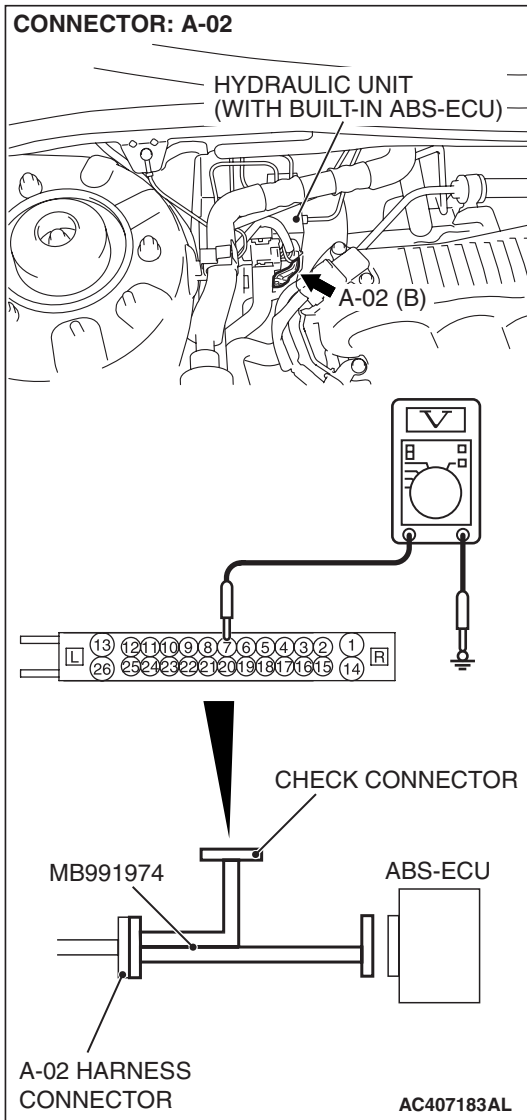

STEP 1. Measure the voltage at ABS-ECU connector A-02.

- (1) Disconnect the connector A-02, and connect special tool MB991974 to the wiring harness-side connector.

NOTE: Do not connect special tool MB991974 to the ABS-ECU.

- (2) Turn the ignition switch to the "ON" position.
- (3) Measure the voltage between terminal 7 and ground. It should measure approximately 12 volts (battery positive voltage).

Q: Is battery positive voltage (approximately 12 volts) present?

YES : Go to Step 3.

NO : Go to Step 2.

STEP 2. Check ABS-ECU connector A-02, intermediate connector C-24, junction block connectors C-202, C-203 and ignition switch connector C-308 for loose, corroded or damaged terminals, or terminals pushed back in the connector.

- ABS-ECU connector A-02

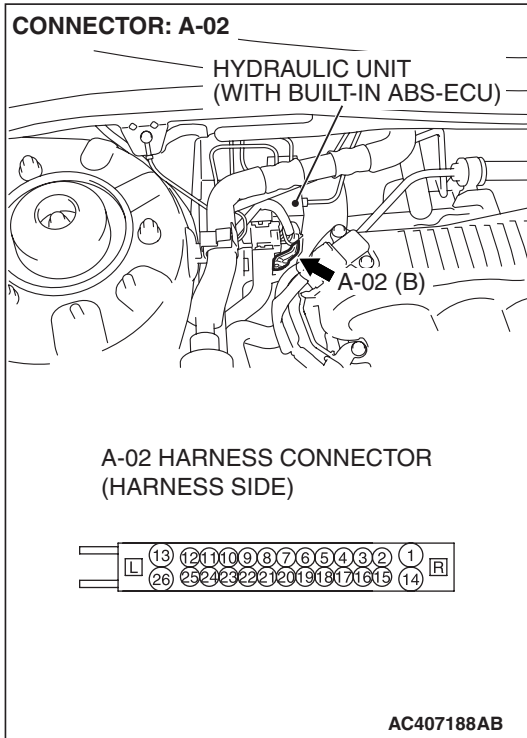

- Intermediate connector C-24

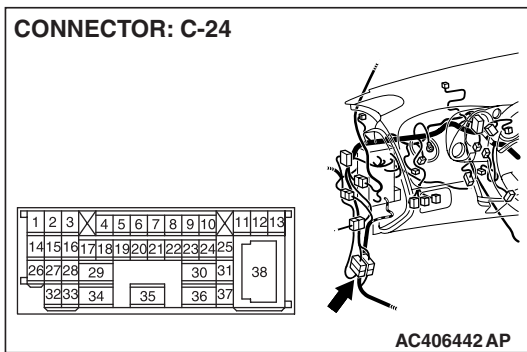

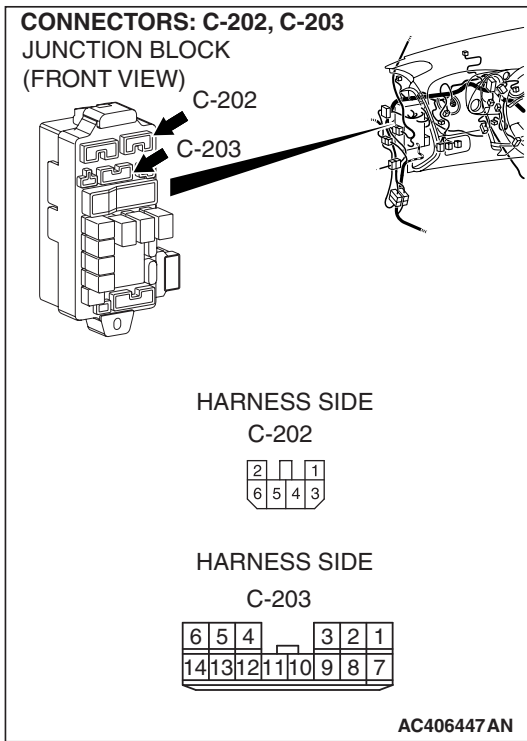

- Junction block connectors C-202 and C-203

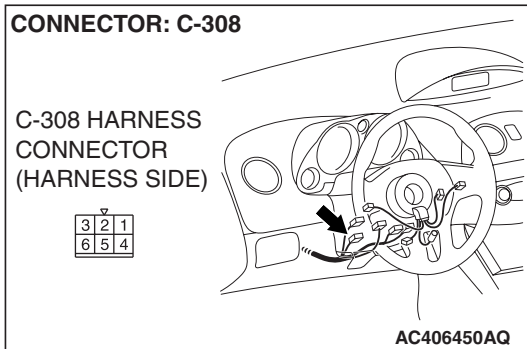

- Ignition switch connector C-308

Q: Are the connectors and terminals in good condition?

YES : An open or short circuit may be present in the power supply line to the ABS-ECU. Repair the wiring harness between ABS-ECU connector A-02 terminal 7 and ignition switch connector C-308 terminal 4. Then go to Step 8.

NO : Repair or replace the damaged component(s). Refer to GROUP 00E, Harness Connector Inspection [P.00E-2](#). Then go to Step 8.

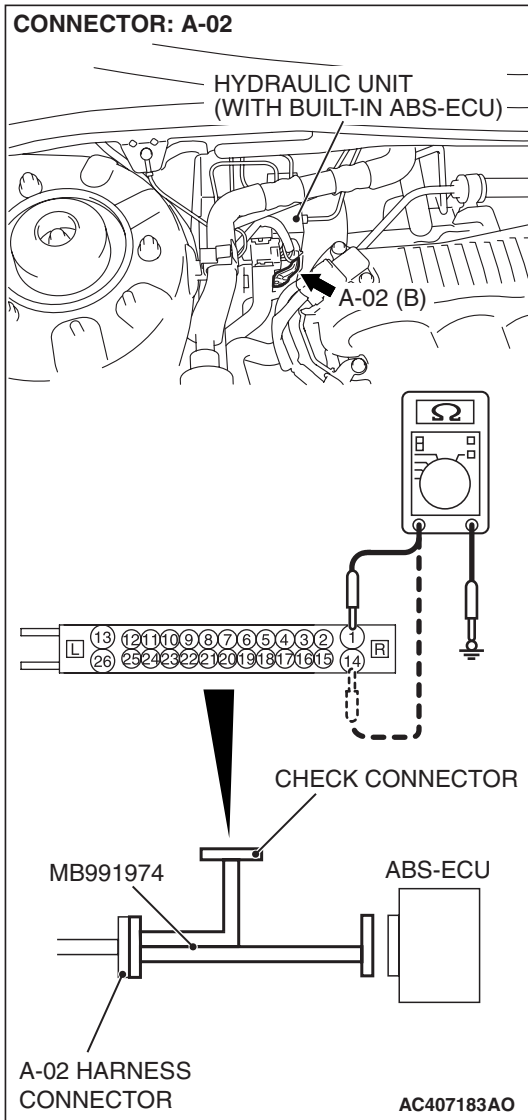

STEP 3. Measure the resistance at ABS-ECU connector A-02.

(1) Disconnect the connector A-02, and connect special tool MB991974 to the wiring harness-side connector.

NOTE: Do not connect special tool MB991974 to the ABS-ECU.

(2) Measure the resistance between terminal 1, 14 and ground. It should be 2 ohms or less.

Q: Is the measured resistance 2 ohms or less?

YES : Go to Step 5.

NO : Go to Step 4.

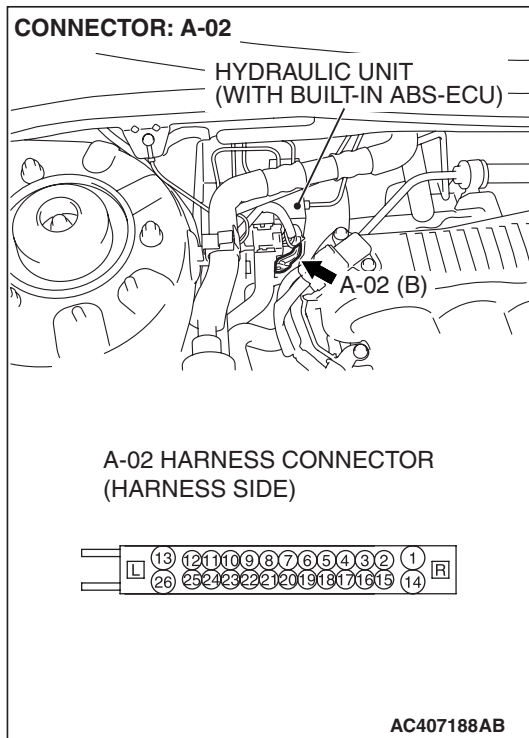

STEP 4. Check ABS-ECU connector A-02 for loose, corroded or damaged terminals, or terminals pushed back in the connector.

Q: Is ABS-ECU connector A-02 damaged?

YES : Repair or replace the damaged component(s). Refer to GROUP 00E, Harness Connector Inspection

[P.00E-2](#). Then go to Step 8.

NO : An open circuit may be present in the ground circuit. Repair the wiring harness between ABS-ECU connector A-02 terminals 1, 14 and the body ground. Then go to Step 8.

STEP 5. Check the battery.

Check the battery (Refer to GROUP 54A, Battery test [P.54A-6](#)).

Q: Is the battery in good condition?

YES : Go to Step 6.

NO : Charge or replace the battery. Then go to Step 8.

STEP 6. Check the charging system.

Check the charging system (Refer to GROUP 16, Charging system diagnosis [P.16-4](#)).

Q: Is the charging system in good condition?

YES : Go to Step 7.

NO : Repair or replace the charging system component(s). Then go to Step 8.

STEP 7. Retest the system.

Q: Can the ABS-ECU communicate with the scan tool (MUT-III Sub Assembly)?

YES : It can be assumed that this malfunction is intermittent. Refer to GROUP 00, How to Use

Troubleshooting/Inspection Service Points –How to Cope with Intermittent Malfunction [P.00-14](#).

NO : Replace the ABS-ECU. Then go to Step 8.

STEP 8. Retest the system.

**Q: Can the ABS-ECU communicate with the scan tool
(MUT-III Sub Assembly)?**

YES : The procedure is complete.

NO : Go to Step 1.

INSPECTION PROCEDURE 3: When the Ignition Key is Turned to "ON" (Engine Stopped), the ABS Warning Light does not Illuminate.

INSPECTION PROCEDURE 4: The ABS Warning Light Remains Illuminated after the Engine is Started.

Anti-lock Braking System Warning Light and Brake Warning Light Drive Circuit

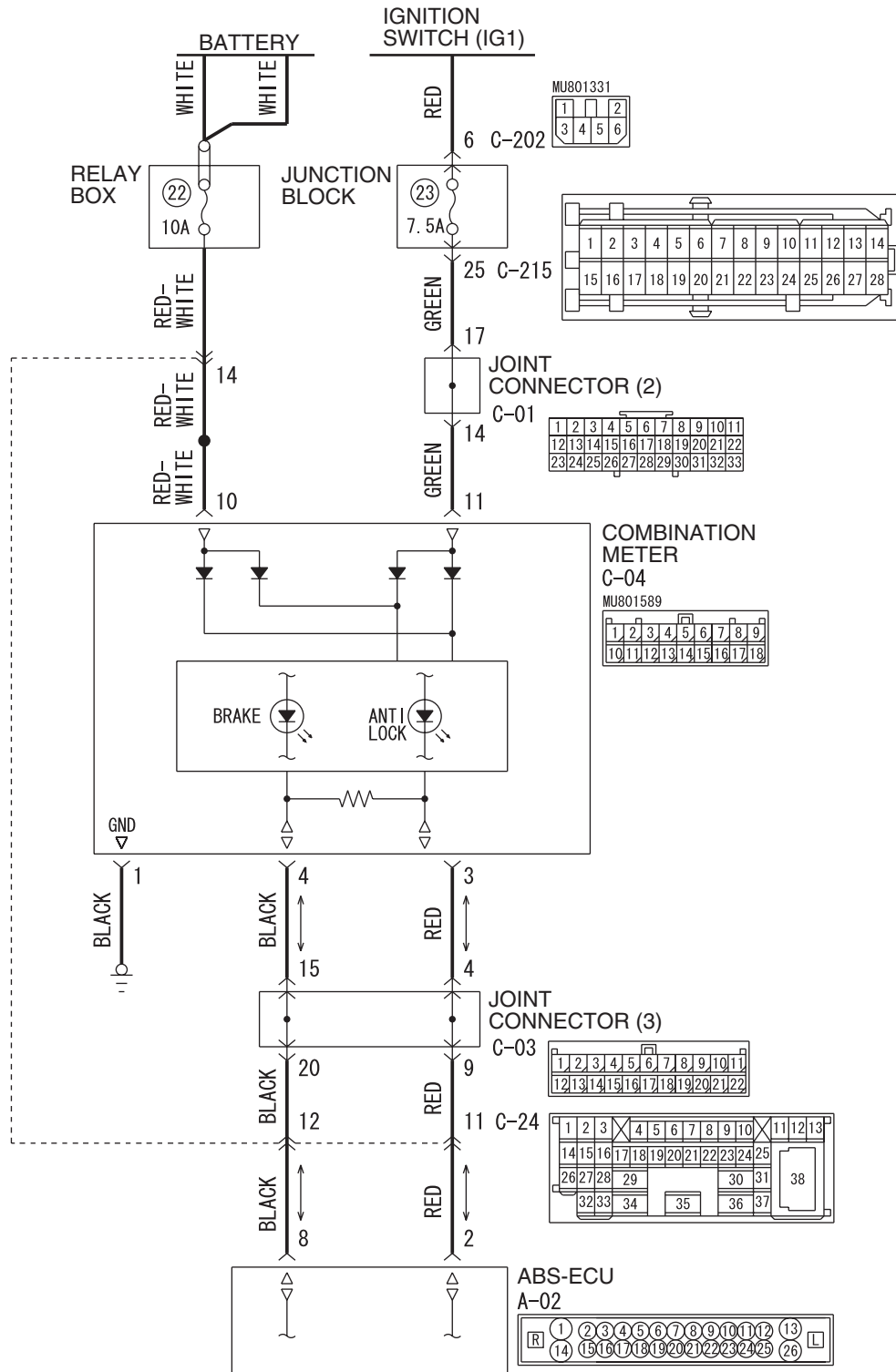

TECHNICAL DESCRIPTION (COMMENT)

- The ABS-ECU sends the ABS warning light and the brake warning light signals to the combination meter via the CAN communication.
- This may be caused by faults in the CAN bus line, the combination meter, or the ABS-ECU.

COMMENT

This may be caused by faults in the CAN bus line, the combination meter or the ABS-ECU.

TROUBLESHOOTING HINTS (THE MOST LIKELY CAUSES FOR THIS CASE:)

- Damaged wiring harness or connector
- Combination meter defective
- Malfunction of the hydraulic unit (integrated with ABS-ECU)

DIAGNOSIS**Required Special Tools:**

- MB991958: Scan Tool (MUT-III Sub Assembly)
 - MB991824: V.C.I.
 - MB991827: MUT-III USB Cable
 - MB991910: MUT-III Main Harness A

STEP 1. Using scan tool MB991958, diagnose the CAN bus line.**⚠ CAUTION**

To prevent damage to scan tool MB991958, always turn the ignition switch to the "LOCK" (OFF) position before connecting or disconnecting scan tool MB991958.

- (1) Connect scan tool MB991958 to the data link connector.
- (2) Turn the ignition switch to the "ON" position.
- (3) Diagnose the CAN bus line.
- (4) Turn the ignition switch to the "LOCK" (OFF) position.

Q: Is the CAN bus line found to be normal?

YES : Go to Step 2

NO : Repair the CAN bus line (Refer to GROUP 54C, Diagnosis P.54C-14). Then go to Step 4.

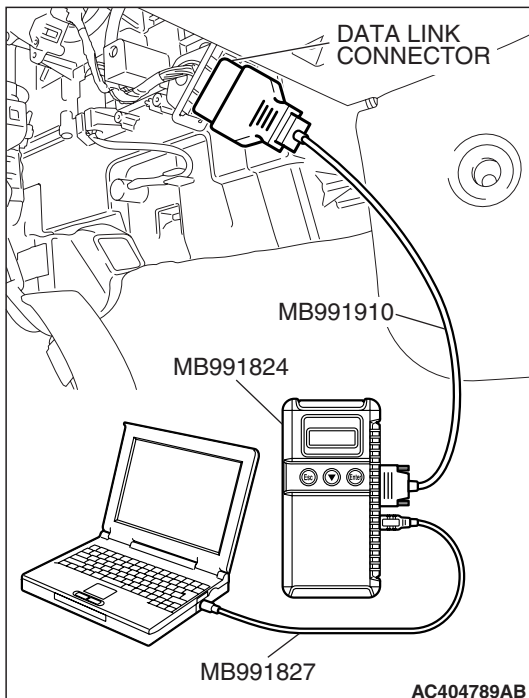

STEP 2. Using scan tool MB991958, read the diagnostic trouble code.

⚠ CAUTION

To prevent damage to scan tool MB991958, always turn the ignition switch to the "LOCK" (OFF) position before connecting or disconnecting scan tool MB991958.

- (1) Turn the ignition switch to the "ON" position.
- (2) Erase the DTC.
- (3) Turn the ignition switch to the "LOCK" (OFF) position.
- (4) Turn the ignition switch to the "ON" position.
- (5) Check if the DTC is set.
- (6) Turn the ignition switch to the "LOCK" (OFF) position.

Q: Is any DTC set?

YES : Refer to [P.35B-10](#), Diagnostic Trouble Code Chart. Then go to Step 4.

NO : Go to Step 3.

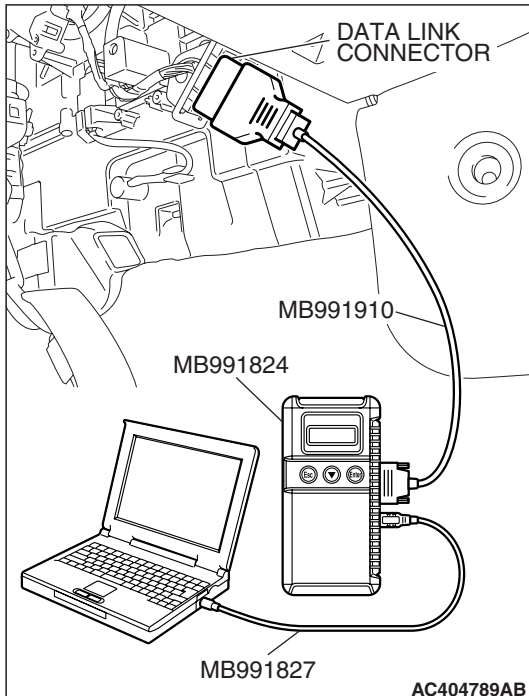

STEP 3. Using scan tool MB991958, read the diagnostic trouble code.

⚠ CAUTION

To prevent damage to scan tool MB991958, always turn the ignition switch to the "LOCK" (OFF) position before connecting or disconnecting scan tool MB991958.

- (1) Connect scan tool MB991958 to the data link connector.
- (2) Turn the ignition switch to the "ON" position.
- (3) Check for Combination meter system diagnostic trouble code. (Refer to GROUP 54A, Combination Meter Assembly Diagnosis –Diagnosis Function –How to Read and Erase Diagnostic Trouble Code [P.54A-52](#)).
- (4) Turn the ignition switch to the "LOCK" (OFF) position.

Q: Is DTC U1102 set?

YES : Replace the hydraulic unit (integrated with ABS-ECU). Then go to Step 4.

NO : Replace the combination meter assembly. (Refer to GROUP 54A –Combination Meter Assembly [P.54A-131](#)). Then go to Step 4.

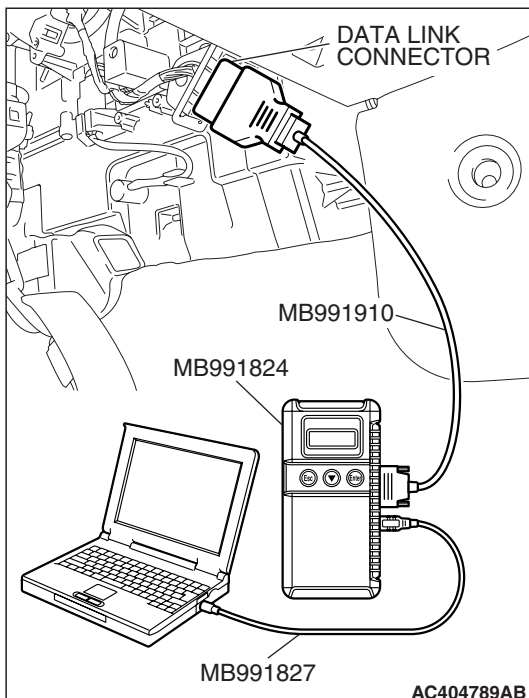

STEP 4. Retest the system

Q: Turn the ignition switch to the "ON" position. Do the ABS warning light illuminate for three seconds, and then go out after the engine starts?

YES : The procedure is complete.

NO : Return to Step 1.

INSPECTION PROCEDURE 5: Faulty ABS Operation

TECHNICAL DESCRIPTION (COMMENT)

The cause depends on driving and road surface conditions, so diagnosis may be difficult. However, if no diagnostic trouble code is displayed, carry out the following inspection.

TROUBLESHOOTING HINTS (THE MOST LIKELY CAUSES FOR THIS CASE:)

- Malfunction of the hydraulic unit

DIAGNOSIS

STEP 1. Hydraulic unit check

Refer to [P.35B-138](#).

Q: Is the hydraulic unit normal?

YES : Go to Step 2.

NO : Connect the brake pipes correctly, repair the external brake lines, or replace the hydraulic unit.

STEP 2. Verify that the condition described by the customer exists.

Q: Can any faults be found with the brake operation?

YES : Check the brake system related components except the ABS system.

NO : The procedure is complete.

DATA LIST REFERENCE TABLE

M1352011500843

The following items can be read by the scan tool from the ABS-ECU input data.

MUT-III SCAN TOOL DISPLAY	ITEM NO.	CHECK ITEM	CHECKING REQUIREMENTS	NORMAL VALUE
FL wheel speed sensor	01	Front-right wheel speed sensor	Drive the vehicle	Vehicle speeds displayed on the speedometer and scan tool are identical.
FR wheel speed sensor	02	Front-left wheel speed sensor		
RL wheel speed sensor	03	Rear-right wheel speed sensor		
RR wheel speed sensor	04	Rear-left wheel speed sensor		
Battery voltage	05	ABS-ECU power supply voltage	Ignition switch power supply voltage and valve monitor voltage	Battery positive voltage
Stoplight switch	06	Stoplight switch	Depress the brake pedal.	ON
			Release the brake pedal.	OFF

ACTUATOR TEST REFERENCE TABLE

M1352011600828

The scan tool activates the following actuators for testing.

NOTE: Actuator testing is only possible when the vehicle is stationary.

NOTE: If the ABS-ECU runs down, actuator testing cannot be carried out.

ACTUATOR TEST SPECIFICATIONS

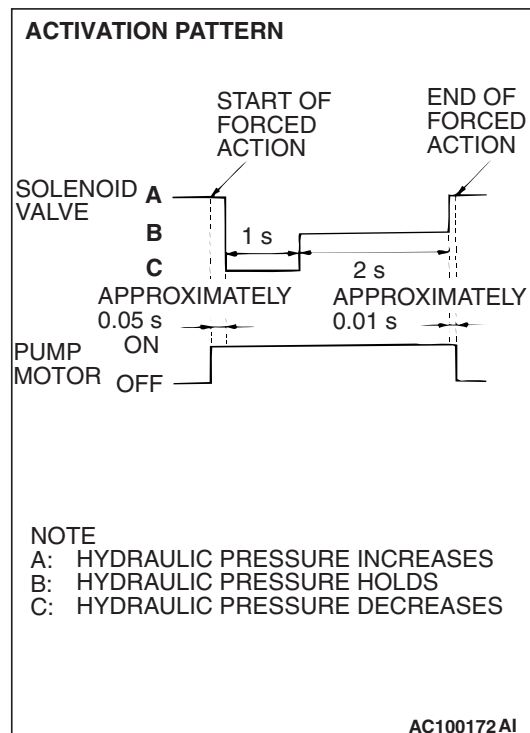

NO.	ITEM	PARTS TO BE ACTIVATED
01	FL wheel speed sensor	Solenoid valves and pump motors in the hydraulic unit (simple inspection mode)
02	FR wheel speed sensor	
03	RL wheel speed sensor	
04	RR wheel speed sensor	

CHECK AT ABS-ECU

M1352011800833

TERMINAL VOLTAGE CHECK CHART

Required Special Tool:

MB991974: ABS Check Harness

1. Disconnect the ABS-ECU connector A-02, and then use special tool MB991970 to measure the voltages between terminals (1) and each terminal other than terminal (14). Also measure voltages between terminal (14) and each terminal other than terminal (1).

NOTE: Do not measure terminal voltage for approximately three seconds after the ignition switch is turned "ON." The ABS-ECU performs the initial check during that period.

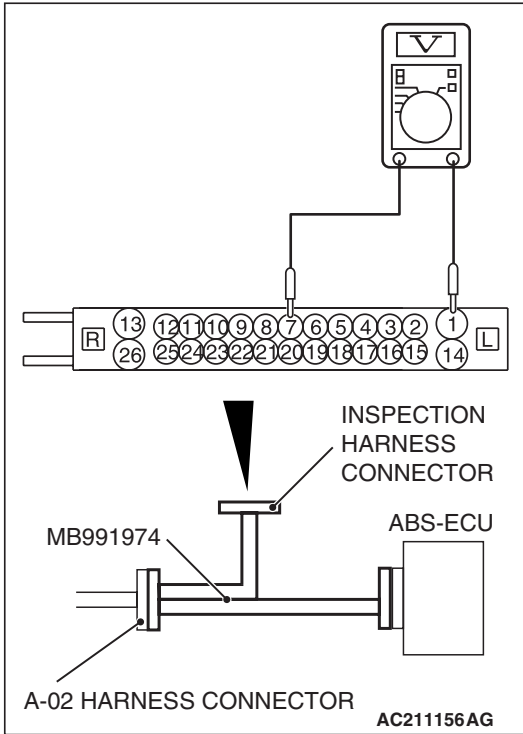

2. The terminal voltage checks specifications are shown below.

CONNECTOR TERMINAL NO	SIGNAL	CHECKING REQUIREMENT		NORMAL CONDITION
7	ABS-ECU power supply	Ignition switch: "ON"		Battery positive voltage
		Ignition switch: "START"		Approximately 0 V
11	Stop light switch input	Ignition switch: "ON"	Stop light switch: "ON"	Battery positive voltage
			Stop light switch: "OFF"	Approximately 0 V
13	Motor power supply	Always		Battery positive voltage
26	Solenoid valve power supply	Always		Battery positive voltage

**RESISTANCE AND CONTINUITY BETWEEN
HARNESS-SIDE CONNECTOR TERMINALS**

Required Special Tool:

MB991974: ABS Check Harness

1. Turn the ignition switch to the "LOCK" (OFF) position and disconnect the ABS-ECU connectors before checking resistance and continuity.
2. Check the resistance and continuity between the terminals indicated in the table below.
3. The terminal layout is shown in the illustration.

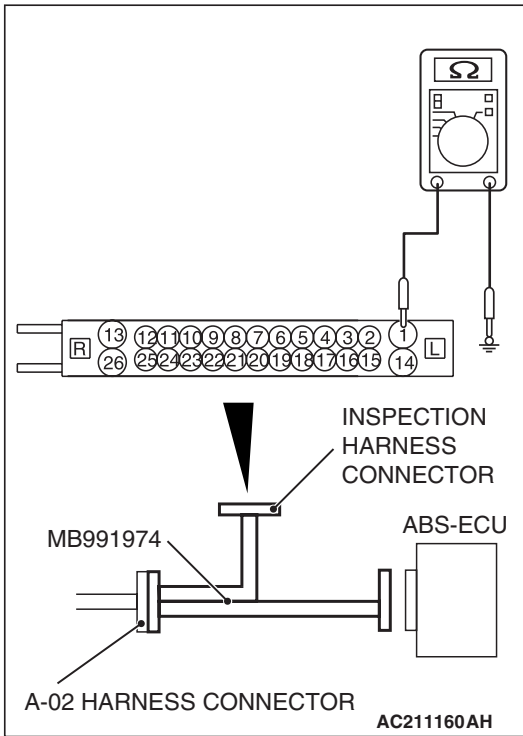



CONNECTOR TERMINAL NO.	SIGNAL	NORMAL CONDITION
21 –22	Front-right wheel speed sensor	1.24 –1.64 kΩ
15 –16	Rear-right wheel speed sensor	1.24 –1.64 kΩ
18 –19	Front-left wheel speed sensor	1.24 –1.64 kΩ
24 –25	Rear-left wheel speed sensor	1.24 –1.64 kΩ
1 –body ground	Ground	Less than 2 ohms
14 –body ground	Ground	Less than 2 ohms

SPECIAL TOOLS

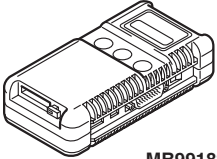
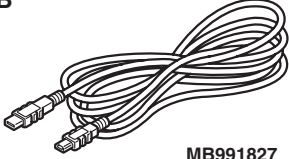
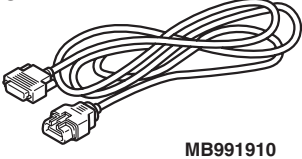
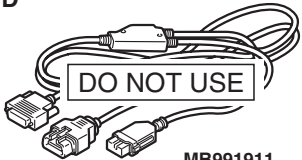
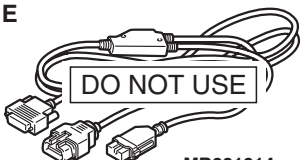
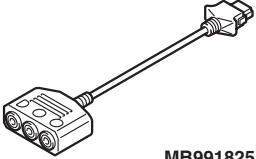
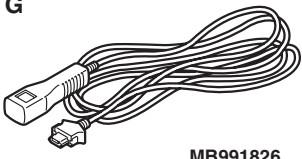
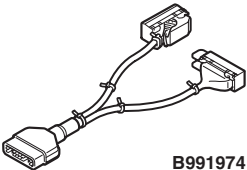
M135200600987

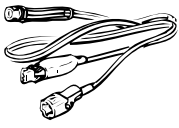
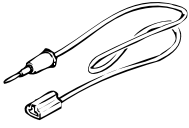
TOOL	TOOL NUMBER AND NAME	SUPERSESION	APPLICATION
<p>A</p>  <p>MB991824</p> <p>B</p>  <p>MB991827</p> <p>C</p>  <p>MB991910</p> <p>D</p>  <p>MB991911</p> <p>E</p>  <p>MB991914</p> <p>F</p>  <p>MB991825</p> <p>G</p>  <p>MB991826 MB991958</p>	<p>MB991958</p> <p>A: MB991824 B: MB991827 C: MB991910 D: MB991911 E: MB991914 F: MB991825 G: MB991826</p> <p>MUT-III Sub Assembly</p> <p>A: Vehicle Communication Interface (V.C.I.) B: MUT-III USB Cable C: MUT-III Main Harness A (Vehicles with CAN communication system) D: MUT-III Main Harness B (Vehicles without CAN communication system) E: MUT-III Main Harness C (for Daimler Chrysler models only) F: MUT-III Adapter Harness G: MUT-III Trigger Harness</p>	<p>MB991824-KIT</p> <p><i>NOTE: G: MB991826 MUT-III Trigger Harness is not necessary when pushing V.C.I. ENTER key.</i></p>	<p>Checking diagnostic trouble codes</p> <p>CAUTION</p> <p>For vehicles with CAN communication, use MUT-III main harness A to send simulated vehicle speed. If you connect MUT-III main harness B instead, the CAN communication does not function correctly.</p>
 <p>B991974</p>	<p>MB991974 ABS check harness</p>		<p>ABS-ECU terminal voltage measurement</p>

TOOL	TOOL NUMBER AND NAME	SUPERSESSION	APPLICATION
<p>A</p>     <p align="right">MB991223AH</p>	<p>MB991223 Harness set A: MB991219 Inspection harness</p>	<p>General service tools</p>	<p>Wheel speed sensor output voltage measurement</p>

ON-VEHICLE SERVICE

WHEEL SPEED SENSOR OUTPUT VOLTAGE MEASUREMENT

M1352001600708

Required Special Tool:

MB991974: ABS check Harness

1. Release the parking brake and lift up the vehicle.
2. Disconnect the ABS-ECU connector A-02, and then use special tool MB991974 to measure the output voltage at the harness side connector.

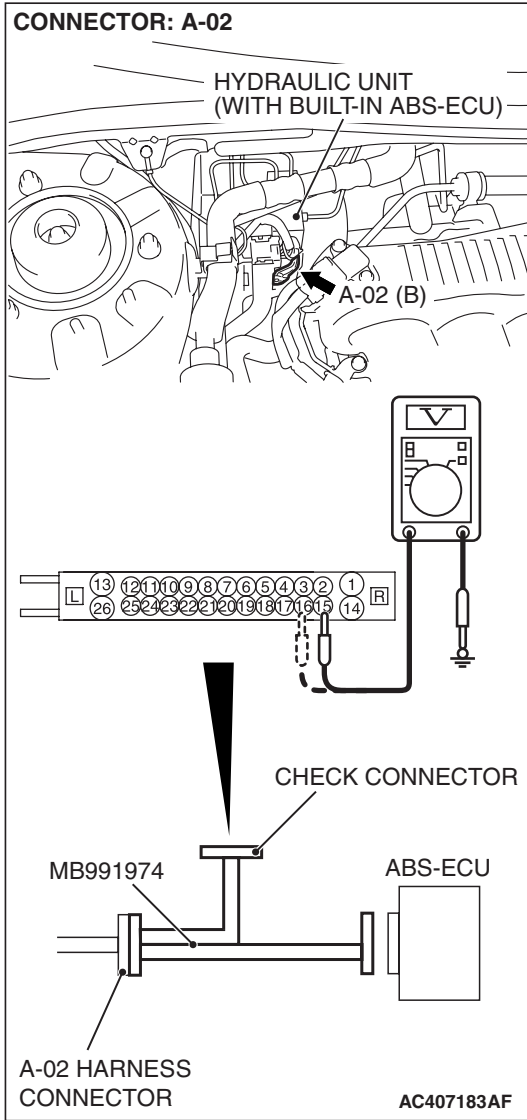

TERMINAL NO.			
Front left	Front right	Rear left	Rear right
18	21	24	15
19	22	25	16

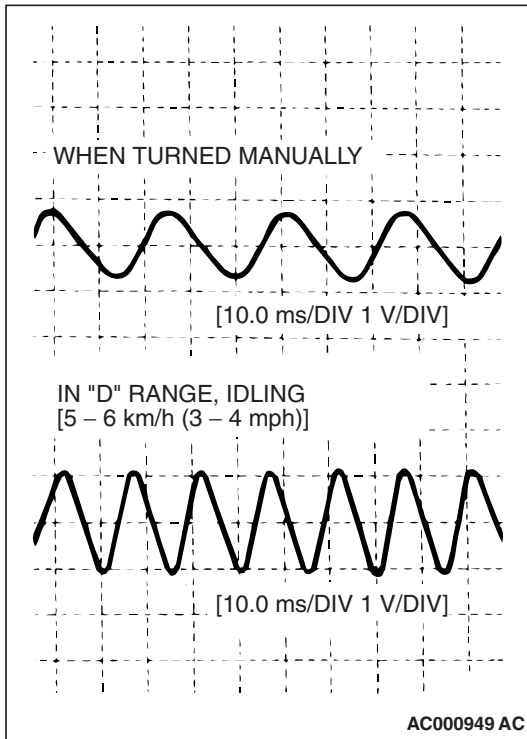

3. Manually turn the wheel to be measured 1/2 to 1 turn/second. Measure the output voltage with a voltmeter or oscilloscope.

NOTE: Check the connection of the sensor harness and connector before using the oscilloscope.

Output voltage:

- Minimal voltmeter reading: 42 mV
- Maximum voltmeter reading: 300 mV
- Minimal oscilloscope reading: 120 mV
- Maximum oscilloscope reading: 600 mV

Probable causes of low output voltage

- Wheel speed sensor pole piece to wheel speed rotor clearance too large
 - Faulty wheel speed sensor
4. To observe the waveform with an oscilloscope:
 - Front Wheels: Shift into "D" range and drive the wheels.
 - Rear Wheels: Turn the wheels manually at a constant speed

NOTE: The output waveform is low when the wheel speed is low. Similarly, it will be higher as the wheel speed increases. Waveform may also be observed by driving the vehicle.

POINTS IN WAVEFORM MEASUREMENT

SYMPTOM	PROBABLE CAUSE	REMEDY
Too small or zero waveform amplitude	Faulty wheel speed sensor or excessive gap between it and the wheel speed rotor	Replace wheel speed sensor
Waveform amplitude fluctuates excessively (This is no problem if the minimum amplitude is 100 mV or more)	Axle hub eccentric or with large runout	Replace hub assembly
	Faulty ABS-ECU ground	Repair harness wires
Noisy or disturbed waveform	Open circuit in wheel speed sensor	Replace wheel speed sensor
	Open circuit in harness	Repair harness wire
	Incorrectly mounted wheel speed sensor	Mount wheel speed sensor correctly
	Wheel speed rotor with missing or damaged teeth	Replace wheel speed rotor

NOTE: The wheel speed sensor cable moves in relation to motion of the front or rear suspension. Therefore, it is likely that it has an open circuit only when driving on rough roads but it functions normally when driving on smooth roads. It is recommended to observe sensor output voltage waveform also under special conditions, such as driving on a rough road.

HYDRAULIC UNIT CHECK

M1352001700802

Required Special Tools:

- MB991958: MUT-III Sub Assembly
 - MB991824: V.C.I.
 - MB991827: MUT-III USB Cable
 - MB991910: MUT-III Main Harness A

⚠ CAUTION

- The roller of the braking force tester and the tire should be dry during testing.
- When testing the front brakes, apply the parking brake. When testing the rear brakes, stop the front wheels with chocks.

1. Jack up the vehicle. Then support the vehicle with rigid racks at the specified jack-up points or place the front or rear wheels on the rollers of the braking force tester.
2. Release the parking brake, and feel the drag force (drag torque) on each road wheel. When using the braking force tester, take a reading of the brake drag force.

⚠ CAUTION

To prevent damage to scan tool MB991958, always turn the ignition switch to the "LOCK" (OFF) position before connecting or disconnecting scan tool MB991958.

3. Connect scan tool MB991958 to the data link connector.
4. After checking that the selector lever is in "P" range, start the engine.
5. Select "Interactive Diagnosis" from the start-up screen.
6. Select "System Select."
7. Choose "ABS" from the "CHASSIS" tab.
8. Select "Actuator Test" from "ABS" screen
9. Choose an appropriate item for hydraulic unit check.

NOTE: The ABS system will switch to the scan tool mode and the ABS warning light will illuminate.

NOTE: When the ABS has been interrupted by the fail-safe function, scan tool MB991958 actuator testing cannot be used.

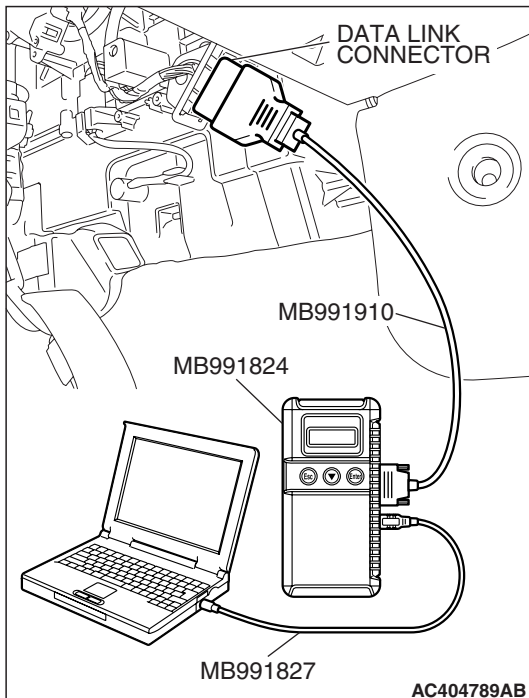

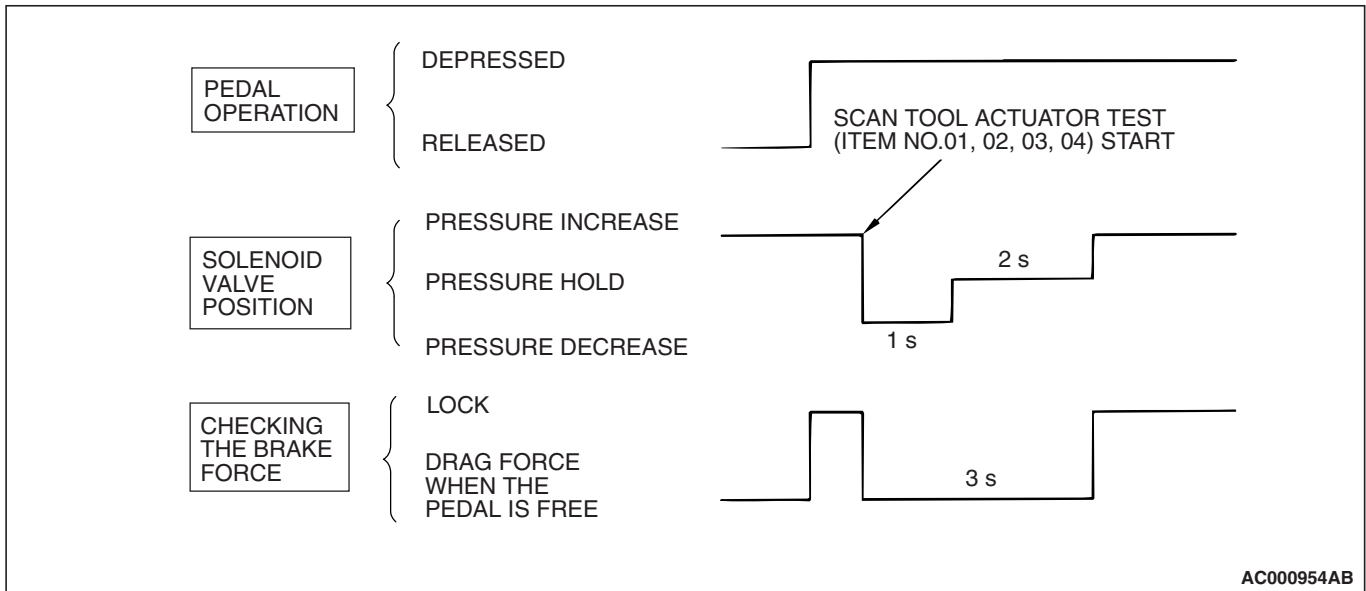

10. Turn the wheel by hand and check the change in braking force when the brake pedal is depressed. When using the braking force tester, depress the brake pedal until the braking force is at the following values, and check that the braking force changes to the brake drag force reading taken in step 2 when the actuator is force-driven. The result should be as shown in the diagram above.

Front wheel	785 – 981 N (176 – 220 lb)
Rear wheel	588 – 784 N (132 – 176 lb)

11. If the result of inspection is abnormal, repair according to the Diagnosis Table below.

DIAGNOSIS TABLE					
MUT-III SCAN TOOL DISPLAY	OPERATION	INSPECTION RESULT	JUDGMENT	PROBABLE CAUSE	REMEDY
01 FL VALVE 02 FR VALVE 03 RL VALVE 04 RR VALVE	<ul style="list-style-type: none"> Depress brake pedal to lock wheel. Using scan tool MB991958, select the wheel to be checked and force the actuator to operate. Turn the selected wheel manually to check the change of brake force. 	Brake force is released for three seconds after wheels have been locked.	Normal	–	–
		Wheel does not lock when brake pedal is depressed.	Abnormal	Clogged brake line other than hydraulic unit	Check and clean brake line
				Clogged hydraulic circuit in hydraulic unit	Replace hydraulic unit assembly
		Brake force is not released	Abnormal	Incorrect hydraulic unit brake tube connection	Connect correctly
				Hydraulic unit solenoid valve not functioning correctly	Replace hydraulic unit assembly

12. After inspection, disconnect scan tool MB991958 immediately after turning the ignition switch to the "LOCK" (OFF) position.

IN THE EVENT OF A DISCHARGED BATTERY

M1352003500677

WARNING

If the ABS is not operating, the vehicle will be unstable during braking, Do not drive the vehicle with the ABS-ECU connector disconnected or with the ABS not operating.

If the engine is started using a booster cable when the battery is completely flat, and the vehicle is then driven without waiting for the battery to be recharged, the engine may misfire and it may not be possible to drive the vehicle. This is because the ABS consumes a large amount of current when carrying out its initial checks. If this happens, recharge the battery fully.

HYDRAULIC UNIT

REMOVAL AND INSTALLATION

M1352008600613

<2.4L ENGINE>

NOTE: The ABS-ECU is integrated in the hydraulic unit.

Pre-removal Operation

- Air Cleaner To Throttle Body Duct Removal (Refer to GROUP 15, Air Cleaner P.15-4).
- Brake Fluid Draining

Post-installation Operation

- Brake Fluid Filling
- Brake Line Bleeding (Refer to GROUP 35A, On-vehicle Service –Bleeding P.35A-17).
- Hydraulic Unit Check (Refer to P.35B-138).
- Air Cleaner To Throttle Body Duct Installation (Refer to GROUP 15, Air Cleaner P.15-4).

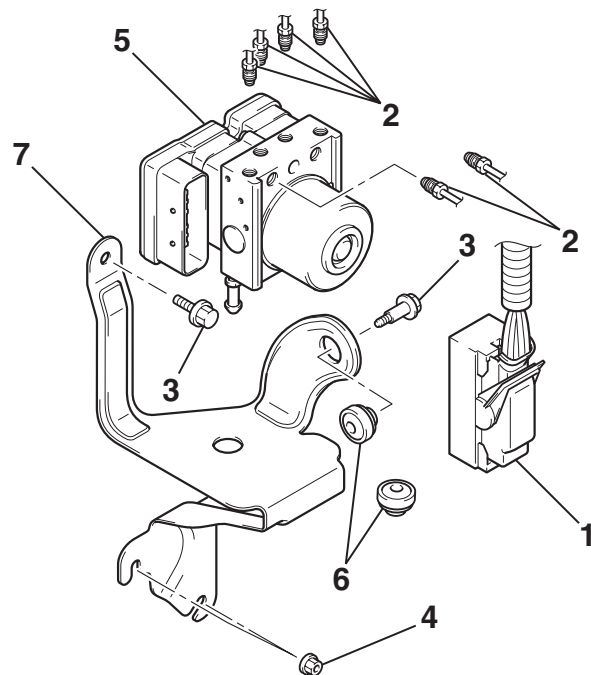
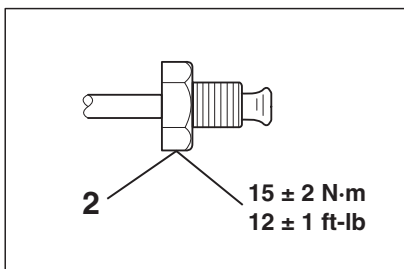
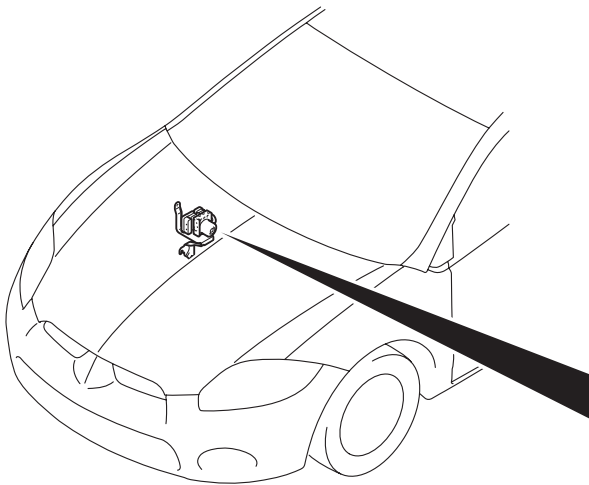

AC407370AB

<<A>>

- REMOVAL STEPS**
1. HARNESS CONNECTOR
 - >>A<< 2. BRAKE TUBE CONNECTION
 3. ABS EQUIPMENT BOLTS
 4. ABS EQUIPMENT NUTS

<>

- REMOVAL STEPS (Continued)**
5. BRAKE MODULATOR HYDRAULIC UNIT <HYDRAULIC UNIT AND ABS-ECU>
 6. INSULATOR
 7. BRAKE HYDRAULIC UNIT BRACKET

<3.8L ENGINE>

NOTE: The ABS-ECU or ABS/TCL-ECU (option) is integrated in the hydraulic unit.

<p>Pre-removal Operation</p> <ul style="list-style-type: none"> • Strut Tower Bar Removal (Refer to GROUP 42, Strut Tower Bar P.42-12). • Air Cleaner To Throttle Body Duct Removal (Refer to GROUP 15, Air Cleaner P.15-5). • Intake Manifold Plenum Removal (Refer to GROUP 15, Intake Manifold Plenum P.15-7). • Brake Fluid Draining 	<p>Post-installation Operation</p> <ul style="list-style-type: none"> • Brake Fluid Filling • Brake Line Bleeding (Refer to GROUP 35A, On-vehicle Service –Bleeding P.35A-17). • Hydraulic Unit Check (Refer to P.35B-138). • Intake Manifold Plenum Installation (Refer to GROUP 15, Intake Manifold Plenum P.15-7). • Air Cleaner To Throttle Body Duct Installation (Refer to GROUP 15, Air Cleaner P.15-5). • Strut Tower Bar Installation (Refer to GROUP 42, Strut Tower Bar P.42-12).
---	---

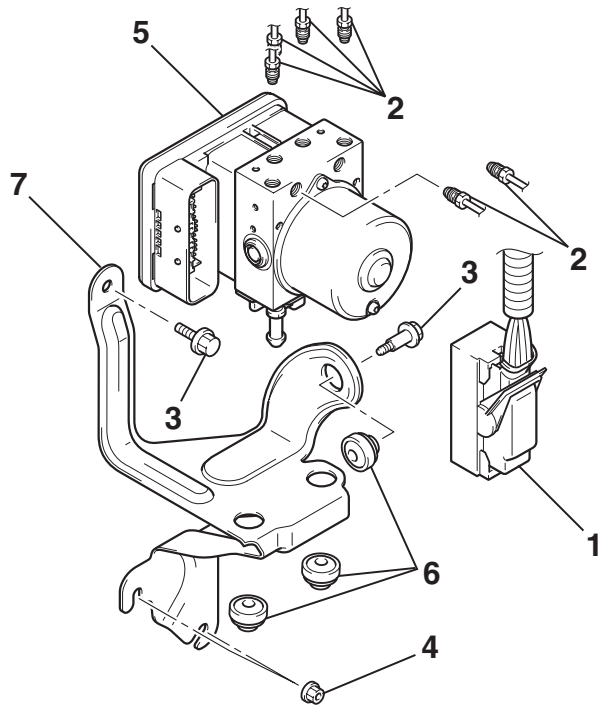
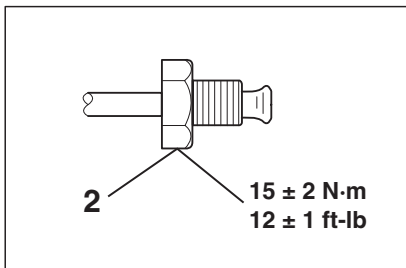
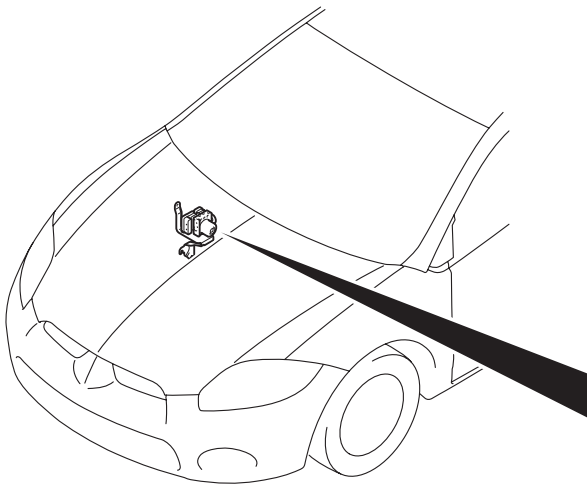

AC407371AB

REMOVAL STEPS

- ENGINE COVER
- HARNESS CONNECTORS AROUND THE ABS-ECU
- HARNESS CLAMPS AROUND THE ABS-ECU
- CONNECTOR BRACKETS AROUND THE ABS-ECU

<<A>>

- 1. HARNESS CONNECTOR
- 2. BRAKE TUBE CONNECTION

<>

REMOVAL STEPS (Continued)

- EGR PIPE (REFER TO GROUP 15, INTAKE AND EXHAUST P.15-7).
- 3. ABS EQUIPMENT BOLTS
- 4. ABS EQUIPMENT NUTS
- 5. BRAKE MODULATOR HYDRAULIC UNIT <HYDRAULIC UNIT AND ABS-ECU OR ABS/TCL-ECU (OPTION)>
- 6. INSULATOR
- 7. BRAKE HYDRAULIC UNIT BRACKET

REMOVAL SERVICE POINTS

<<A>> HARNESS CONNECTOR DISCONNECTION

Move the lock lever of the ABS-ECU connector or ABS/TCL-ECU connector <3.8L Engine (Option)> as shown in the illustration, and then disconnect the harness connector.

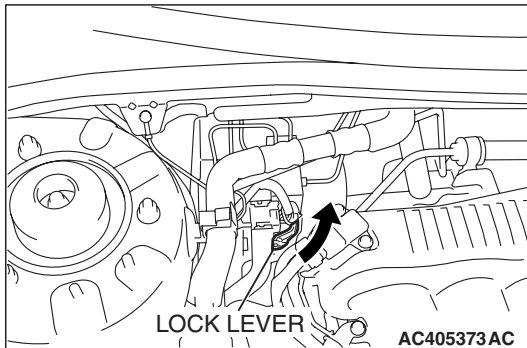

<> BRAKE MODULATOR HYDRAULIC UNIT [HYDRAULIC UNIT AND ABS-ECU OR ABS/TCL-ECU <3.8L ENGINE (OPTION)>] REMOVAL

⚠ WARNING

The hydraulic unit is heavy. Use care when removing it.

⚠ CAUTION

- The hydraulic unit cannot be disassembled. Never loosen its nuts or bolts.
- Do not drop or shock the hydraulic unit.
- Do not turn the hydraulic unit upside down or lay it on its side.

INSTALLATION SERVICE POINT

>>A<< BRAKE TUBE CONNECTION

Connect the tubes to the hydraulic unit assembly as shown in the illustration.

1. From the master cylinder (secondary)
2. From the master cylinder (primary)
3. To the front brake (RH)
4. To the front brake (LH)
5. To the rear brake (LH)
6. To the rear brake (RH)

<2.4L ENGINE>

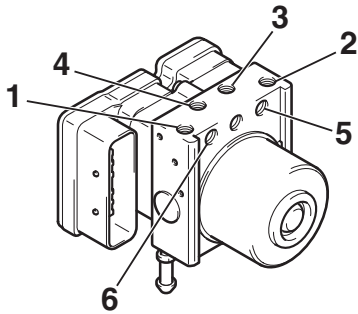

<3.8L ENGINE>

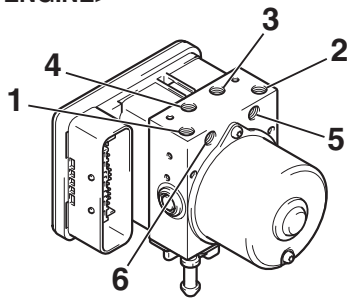

AC407194AB

WHEEL SPEED SENSOR

REMOVAL AND INSTALLATION

M1352008300805

Post-installation Operation

- Wheel Speed Sensor Output Voltage Measurement (Refer to [P.35B-136](#)).

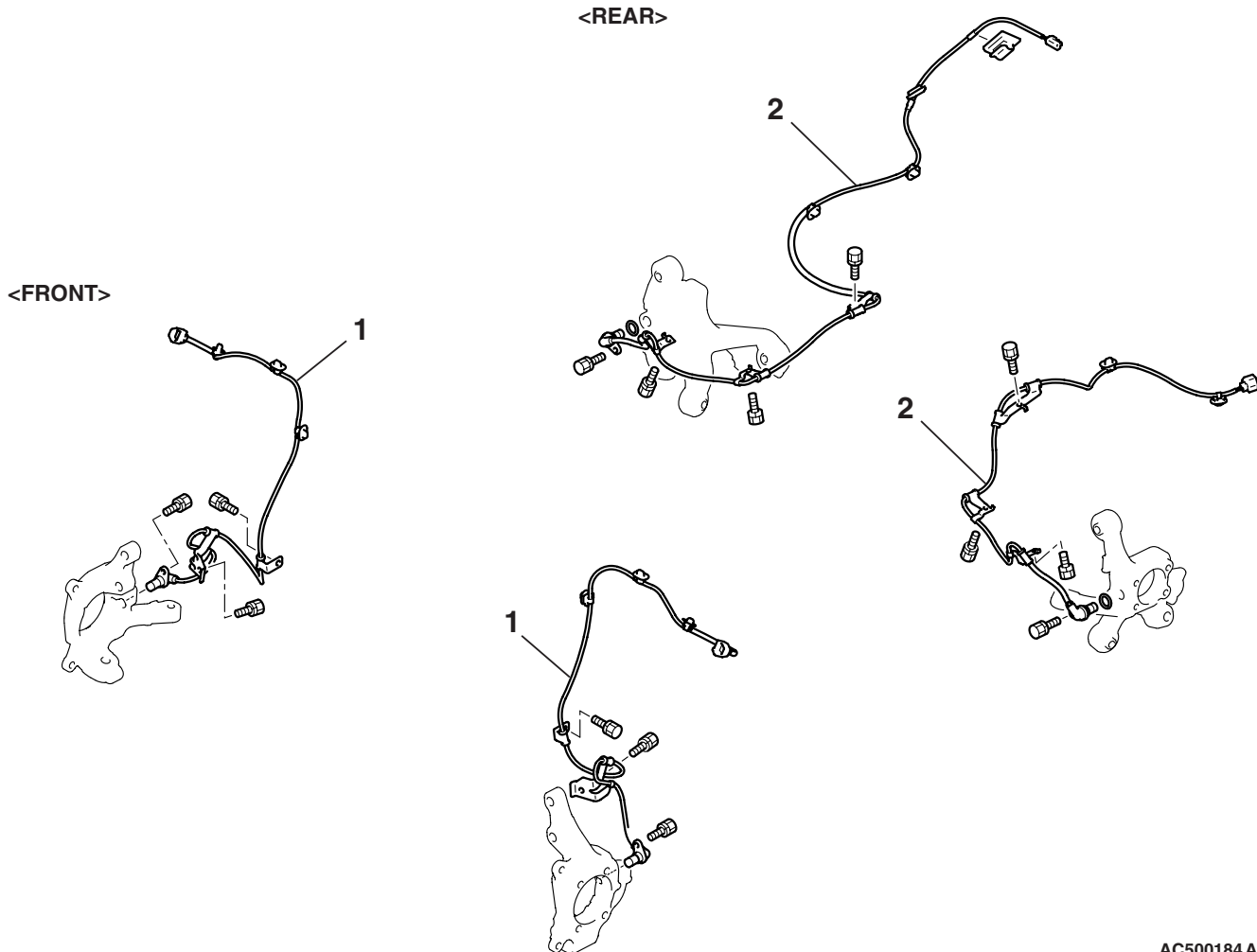

AC500184 AB

FRONT WHEEL SPEED SENSOR REMOVAL STEPS

<<A>>

- SPLASH SHIELD (REFER TO GROUP 42, FENDER [P.42-10](#)).
- 1. FRONT WHEEL SPEED SENSOR
- FRONT WHEEL SPEED ROTOR (REFER TO GROUP 26, DRIVESHAFT ASSEMBLY [P.26-14](#)).

<<A>>

REAR WHEEL SPEED SENSOR REMOVAL STEPS

- 2. REAR WHEEL SPEED SENSOR
- REAR WHEEL SPEED ROTOR (REFER TO GROUP 27, REAR AXLE HUB ASSEMBLY [P.27-6](#)).

NOTE: Front wheel speed rotors are integrated with the BJ assembly of the drive shaft and cannot be disassembled.

NOTE: Rear wheel speed rotors are integrated with the rear hub assembly and cannot be disassembled.

REMOVAL SERVICE POINT

<<A>> FRONT WHEEL SPEED SENSOR/REAR
WHEEL SPEED SENSOR REMOVAL**⚠ CAUTION**

Be careful when handling the projection at the tip of the wheel speed sensor and the toothed edge of the wheel speed rotor so as not to damage them by contacting other parts.

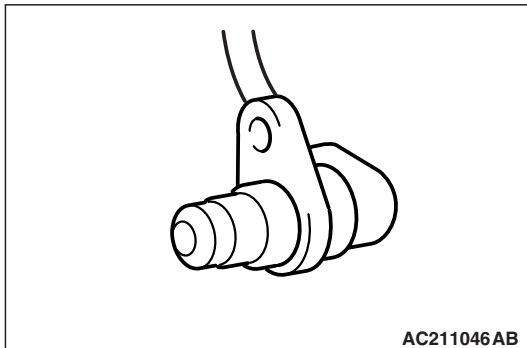

INSPECTION

M1352008400619

WHEEL SPEED SENSOR CHECK

1. Check whether any metallic foreign material has adhered to the projection at the speed sensor tip. Remove any foreign material. Also check whether the pole piece is damaged. Replace it with a new one if it is damaged.

NOTE: The projection can become magnetized due to the magnet inside the wheel speed sensor, causing foreign material to easily adhere to it. The projection may not be able to correctly sense the wheel rotation speed if foreign matter is on it or if it is damaged.

2. Measure the resistance between the wheel speed sensor terminals.

Standard value: 1.24 –1.64 kΩ

3. If the internal resistance of the wheel speed sensor is not within the standard value, replace it with a new wheel speed sensor.

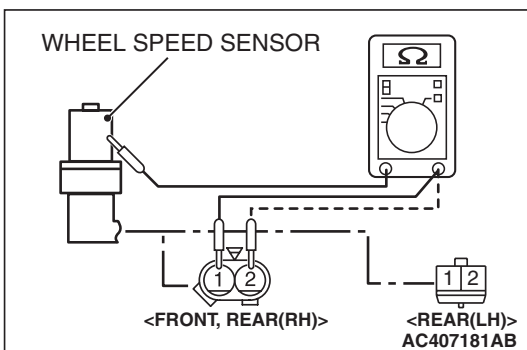
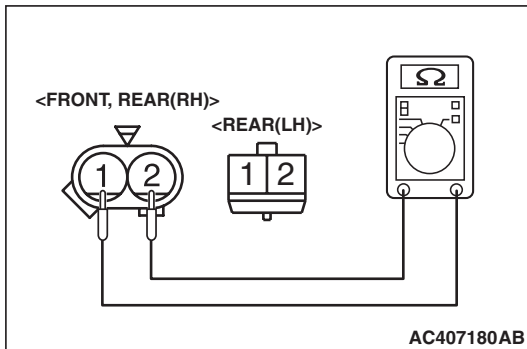

4. Remove all connections from the wheel speed sensor. The circuit should be open between terminals (1) and (2) and the body of the wheel speed sensor. If the circuit is not open, replace with a new wheel speed sensor.
5. Check the wheel speed sensor cable for breakage, damage or disconnection. Replace with a new one if a problem is found.

NOTE: When checking for cable damage, remove the cable clamp part from the body and then gently bend and pull the cable near the clamp.

TOOTHED WHEEL SPEED ROTOR CHECK

Check whether the wheel speed rotor teeth are broken or deformed. Replace the BJ assembly of the drive shaft, or the rear hub assembly, respectively, if the teeth are damaged or deformed.

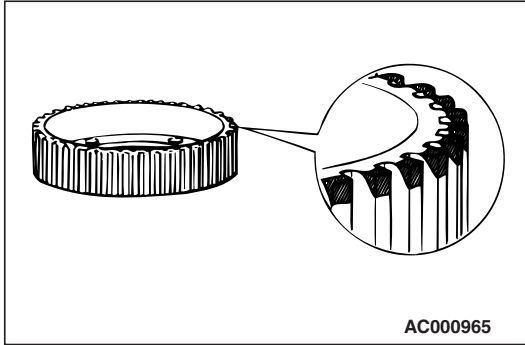

AC000965

SPECIFICATIONS**FASTENER TIGHTENING SPECIFICATION**

M1352012400441

ITEM	SPECIFICATION
Brake tube flare nut	15 ± 2 N·m (12 ± 1 ft-lb)

GENERAL SPECIFICATIONS

M1352000200105

ITEM	SPECIFICATION	
ABS control method	4-sensor, 4-channel	
Numbers of wheel speed rotor teeth	Front	43
	Rear	43
Wheel speed sensor	Type	Magnet coil type
	Gap between sensor and rotor mm (in)	0.2 – 0.5 (0.008 – 0.020) <Non-adjustable type>

SERVICE SPECIFICATION

M1352000300771

ITEM	STANDARD VALUE
Wheel speed sensor internal resistance kΩ	1.24 – 1.64